

LAUFEN



GENERAL
CATALOGUE 2020/21

LAUFEN

ABOUT LAUFEN

The Company	06
The Production	08
The Innovations	10
The History	12
The Designers	14
The References	18

DESIGN LINES

The New Classic	22
Sonar	34
IlBagnoAlessi One	46
Palomba Collection	58
Kartell by Laufen	70
Living Square	88
Living SaphirKeramik	96
Living City	100
Ino	106
Val	118
Palace	132
Laufen Pro S	142
Laufen Pro A	156
Laufen Pro B	162
Laufen Pro	166

WASHBASINS

Bowl Washbasins	180
Washbasins Undersurface Ground	184
Semi-Recessed Washbasins	188
Drop-In Washbasins	190
Under-Mounted Washbasins	192

SHOWER TOILETS

Cleanet Riva	194
Cleanet Navia	202

SPECIAL APPLICATIONS

Florakids	206
Barrier-Free Bathroom	210
Siphonic Toilets	220
Universal Cistern	222
Special Articles / Ceramic Accessories	224
LIS Laufen Installation System	228

BATHROOM FURNITURE

Possible Combinations	236
Overview Furniture Colours	237
Boutique	238
Space	244
Case	250
Base	258
Frame 25	268
Leelo	276

WELLNESS

Sentec Bathtubs	280
Acrylic Bathtubs and Shower Trays	284
Steel Bathtubs and Shower Trays	290
Ceramic Shower Trays	294
Marbond Bathtubs and Shower Trays	296

URINALS

Public Urinals	304
Home Urinals	311
LIS for Urinals	313

FAUCETS

The New Classic	318
Kartell by Laufen	324
Sense	328
Val	332
Curveprime	334
Twinplus	338
Cityplus	342
Citypro	346
Laurin	350
Simibox	352
Twintronic - Digital Public Bathroom	358
Shower Accessories	360

APPENDIX

Product Features and Benefits	364
----------------------------------	-----

LAUFEN – THE COMPANY

LAUFEN stands
for swissness,
quality and design,
offering complete
bathroom
solutions around
the world.



Making the bathroom a living environment

The personality of this highly traditional Swiss brand reflects a symbiosis of design, quality and functionality. LAUFEN is one of the world's leading manufacturers with a global distribution network. The company's core competence is its knowledge in the area of sanitary ware manufacturing. For over 125 years, the LAUFEN brand has been using the oldest malleable material known to man to make innovative sanitary products in state-of-the-art plants with legendary Swiss precision. Knowledge of the bathroom as a whole is developed from the competence of LAUFEN in ceramics manufacturing, and sophisticated design.



BATHROOM CULTURE FOR 125 YEARS

What makes LAUFEN products unique at first glance is that their Swiss design unites two major design trends: emotional Italian design from the south and the northern tradition of design precision

and clarity. For LAUFEN, quality has two aspects: manufacturing knowledge and high degree of practical benefit that the finished bathroom affords the customer – which is often not immediately apparent. LAUFEN, a Swiss company manufacturing products that allow water, a precious resource, to be used sparingly, demonstrates in this manner a commitment to preserving natural resources and environmentally-friendly production.



THE CANTON OF BASELSTADT BETWEEN THE RIVERS DOUBS AND RHINE

From humble beginnings to today's global player

When LAUFEN was founded in Switzerland in 1892, sanitation was still a far cry from the standards and comforts offered today; standards, which were particularly influenced by LAUFEN, the only sanitary ceramics producer that manufactures exclusively in Europe.



FIRST MECHANICAL FACTORY FOR SANITARY WARE ON THE EUROPEAN CONTINENT, ZNOJMO

Some of the production facilities that belong to the company today can be traced back even further into history.

In 1878 for example, the pioneer in the mechanical manufacture of sanitary ceramics was a production site belonging to the Austrian monarchy. It is not just tradition, but also the strong anchor which various European manufacturing sites maintain in their domestic markets, Switzerland, Austria and Czech Republic, that underpin the quality of LAUFEN as a company. LAUFEN's goal then was the same as today's: to lead on technology, service and design.

Back in the 1980s, LAUFEN engineers invented the most efficient high-pressure casting technology for ceramic production and therefore ensured a sustainable breakthrough in industrial production.



DEVELOPMENT OF THE WALL HUNG TOILET BY LAUFEN ENGINEER XAVER JERMANN, 1964

Just as important at LAUFEN are the constant developments in design: wall-mounted WCs and floor-standing washbasins have enabled a new sense of aesthetics. In 2013 LAUFEN's worldwide material innovation SaphirKeramik succeeded in revolutionising the design language of ceramic.

The innovative and valuable patented SaphirKeramik formulation gives the starting material unprecedented possibilities and scopes. SaphirKeramik is used when a design includes thin walled shapes and tight radii.



THE NEW CLASSIC DESIGNED BY MARCEL WANDERS

A building of great symbolic value



THE LAUFEN FORUM IS A 6,500 CUBIC METER ARCHITECTURAL STATEMENT, A VISITOR AND PRESENTATION CENTRE DESIGNED BY BASEL BASED ARCHITECTS NISSEN & WENTZLAFF, PHOTOGRAPHED BY MAURIZIO MERCATO.

LAUFEN is synonymous with perfection in terms of form and craftsmanship and for advanced technology with an unobtrusive face. LAUFEN's headquarters in the canton of Baselland reflect this identity.

Ludovica + Roberto Palomba designed "bowl / 08", a washbasin for the Palomba Collection. Architects Nissen & Wentzlaff then created a larger version of this object in the form of the building which stands out with its impressive exposed concrete and elegant statics.

An inventive spirit and desire for technical innovation are also part of the building's concept and require efficient resource usage and an acceptable ecological footprint. As a result, the multi-award-winning building is an outstanding feature in the Basel area, an area which is rich in superb architecture.

With the Forum, LAUFEN has created a new architectural setting for its products: it is a comprehensive architectural statement in concrete with the bathroom at its centre and acknowledges Switzerland unequivocally as the company's headquarters and production site.

A space for the bathroom with the power to inspire clients, architects, retailers and tradesmen alike as well as providing a source of information. This is also the home of the training centre of LAUFEN Bathrooms AG.

A wide range of seminars is held here to train groups and communicate product knowledge.

Live and in person - LAUFEN Showrooms



IN FOUR EUROPEAN CITIES AND IN MIAMI, YOU CAN EXPERIENCE LAUFEN LIVE

LAUFEN is pursuing a new type of presentation and encounter with the LAUFEN showroom concept, which has so far been implemented in Berlin, Vienna, Prague, Madrid and Miami. Each location has its own identity, with its own individual interior design. In Madrid, interior designer Patricia Urquiola styled the rooms of a historic villa. Prague also hosts temporary exhibitions on an area over 600 m².

EOOS Design drafted the exhibition in Vienna and used analogies to the firing process of ceramics. In Berlin, Konstantin Grcic pursued a clear, industrial, visual and material language with his interior design, which is based on the production in the factory, whilst the showroom in Miami is part of the Miami Ironside, a complex in old industrial halls with offices and restaurants.

Individual solutions

The individual planning and design of bathrooms is a growing segment of the sanitary market. Architects and planners of high-quality private residences in particular, but also public and semi-public buildings, such as hotels, often require individual solutions that can be fitted precisely into the floor plans of sanitary rooms and bathrooms, in order to meet the special requirements of the client. LAUFEN is adapting to these requirements with numerous solutions from its range of products and creating bathrooms made to measure:

These include, for example, washbasins, ceramic shelves, mirrors and bathroom furniture manufactured to the millimetre, but also colour or customisation options. Even faucets can be individualised, and special handles, logos, colours, and surfaces can be provided as required.



TAILOR-MADE SOLUTIONS CAN BE REALISED TO MEET CUSTOMER REQUIREMENTS

In the meantime, modern solid surface materials are also available that can be used to realise individual customer requirements in the shortest possible time in small quantities. When it comes to washbasins, worktops, accessories, furniture, shower trays, bathtubs, sinks, and even wall coverings, there are almost no limits to creative drive.

This enables architects and designers to create their own designs that harmonise perfectly with the room and decor. LAUFEN also offers a complete service package, which includes feasibility checks, assistance with technical drawings, the manufacture of models and prototypes, the adaptation of accessories, direct shipping, and after-sales service.



VARIETY OF SHAPES THANKS TO MINERAL MATERIALS

LAUFEN – THE PRODUCTION

LAUFEN IN FIGURES

LAUFEN BATHROOMS AG IS A SWISS COMPANY SPECIALISING IN PREMIUM SEGMENT SOLUTIONS FOR BATHROOMS. THE HEADQUARTERS ARE LOCATED IN LAUFEN NEAR BASEL. MANAGED BY THE FAMILY-OWNED ROCA GROUP SINCE 1999 LAUFEN RUNS 6 MANUFACTURING SITES IN CENTRAL EUROPE, WITH 2500 EMPLOYEES AND SALES OFFICES IN 44 COUNTRIES.



Global network with local service



PRODUCTION SITES IN CENTRAL EUROPE

1 The company is named after the town of LAUFEN near Basel in Switzerland where it has produced washbasins, bidets and toilets in sanitary ceramic for 125 years. The management of LAUFEN Bathrooms AG, faucet production, training centre and the LAUFEN Forum are also located here.

2 The production facility in Gmunden specialises in the manufacture of highly sophisticated bathroom sanitary ware. The Gmunden facility has acquired this

expertise through a long tradition in ceramics production.

3 The state-of-the-art factory in Znojmo, in the Czech Republic, produces high quality bathroom ceramics. This factory has a long tradition which goes back more than 135 years.

4 Bechyně is not only the home of the oldest vocational school of ceramics in the Czech Republic, it is also a modern factory where high quality ceramics have been produced for more than 50 years.

5 LAUFEN ceramics products are produced in accordance with strict LAUFEN quality standards (LQS) at the state-of-the-art Roca Group factory in Gliwice.

6 In addition, LAUFEN bathtubs are made of acrylic and mineral cast materials in Gryfice, Poland.

Sustainable quality

Economic water flush systems

LAUFEN's 4.5/3-litre toilets meet all functional requirements defined by international standards EN 997 Class 1 Type 5, EN 997 Class 2 and SAI/Wels 4 Stars.

Please take into consideration your local requirements that may vary from country to country.

Find further information in the chapter Product features and benefits.



European water label

The database of the European Water Label provides architects, planners and consumers with a comparative tool that is



- LAUFEN branch
- Worldwide export

valid in the whole of Europe and that allows them to evaluate the water consumption of a water-using product in the bathroom or kitchen at a glance.

Find further information in the chapter Product features and benefits.



Environmental protection standards

Environmentally friendly production of modern, durable and resource-saving products.

Since 1998, LAUFEN has continually monitored the use of resources in all its internal and external processes. Targeted measures and appropriate investments promote the efficient and sustainable use of manufacturing resources. Important key environmental protection indicators now clearly show that LAUFEN production sites fulfill the legally-prescribed environmental protection standards, and in most cases also exceed them.



Certification

The first two LAUFEN production facilities were successfully ISO 14001 certified and EMAS registered in 1997. Both of these factories were awarded the European Environment Prize 2007 for exemplary environmental management. All the LAUFEN production facilities are now certified with the Environmental and Quality Management Systems ISO 9001 and ISO 14001.



Swiss Quality

Products with the Q-Plus certification meet both the European standard and the established more stringent Swiss susisetec/VSA standard. LAUFEN sanitary ware products meet these Swiss quality standards and have been recommended for approval accordingly.



LAUFEN – THE INNOVATIONS

 SaphirKeramik

Freedom to Reshape



SAPHIRKERAMIK VERSUS FINE FIRECLAY

SaphirKeramik, patented and available on the market is one of the latest, globally significant innovation from LAUFEN. This revolutionary, ceramic material reaches its exceptional hardness blended with corundum, a colourless mineral, which is a component of sapphires. This gives SaphirKeramik a flexural strength equal to that of steel. Yet it has the potential to be wafer-thin, giving designers almost infinite freedom to experiment – and tear up the rulebook of bathroom design.

After some years of experience of producing SaphirKeramik pieces on an industrial scale, LAUFEN is now stretching the patented material's limits by exploiting its super-fine forms not only to create exquisitely detailed textures and patterns but also by engineering the innovative material to increase its maximum size – a 120 cm-long washbasin in SaphirKeramik is the largest to date. LAUFEN has also applied its impressively efficient, high-pressure casting technology to, high-volume pieces in SaphirKeramik.

 
Design Preis Schweiz
Prix Design Suisse
Design Prize Switzerland

**design
preis
SCHWEIZ**



THE THIN-WALLED SAPHIRKERAMIK WAS TESTED FOR IMPACT RESISTANCE AT THE KERAMIK INSTITUT MEISSEN

Simultaneously hard and malleable, SaphirKeramik enables pieces to be made with very thin, yet very strong walls of only 3–5 mm, as well as with narrowly defined radii of only 1–2 mm. The slim profile of SaphirKeramik means that it saves space, is light and environmentally friendly. The new design characteristics of this innovative material are rooted in its exceptional hardness and strength.



SAPHIRKERAMIK HAS A TWO TO THREE TIMES HIGHER BENDING RESISTANCE THAN TRADITIONAL CERAMICS

When the mechanical properties of the two traditional sanitary ceramic masses – namely vitreous china and fine fire clay – are compared, the performance of SaphirKeramik is unique even in international comparison.

The comparative values measured by the Federal Institute for Materials Research and Testing in Berlin (BAM) for SaphirKeramik are, at an average of over 120 MPa;

Production of SaphirKeramik with the casting technology invented by LAUFEN

comparable with carbon steel and twice as high as for vitreous china. LAUFEN was awarded the Swiss Design Prize 2017/18 for the development of SaphirKeramik.

„Aspects such as ecology and sustainability may not have been the focus of attention in the development of SaphirKeramik, but they contribute significantly to the positive overall image of the material,” the jury commented. In doing so, it acknowledged the additional advantages of the material: Lower material costs, for example, which are also due to a simplified structure of the ceramic parts, as well as the advantages in terms of environmental protection and sustainability, since fewer raw materials and less energy are used in the firing, production, and transport of SaphirKeramik.



PRODUCTION OF SAPHIRKERAMIK WITH THE CASTING TECHNOLOGY INVENTED BY LAUFEN

«New materials have always been one of the most important driving forces behind the development of design. With SaphirKeramik, the traditional Swiss brand LAUFEN has succeeded in creating an equally surprising and remarkable innovation whose effects on sanitary ceramics can only be estimated to a limited extent today.»

BENDING STRENGTH

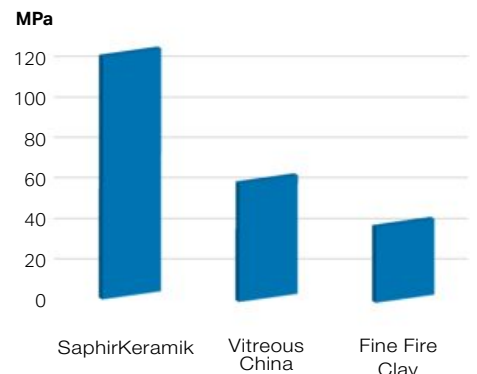

Source: Bundesanstalt für Materialforschung- und Prüfung, Berlin, 2011

IMPACT ENERGY

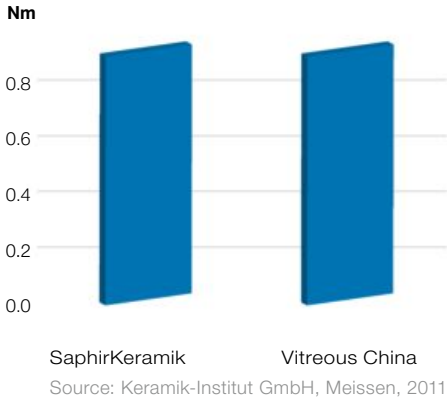

«The composite material, which does not require chemical additives, wows with its specific properties - hardness, bending strength - and offers the enormous economic advantage of being suitable for processing using traditional production processes.» These were the words the jury used to elaborate on their decision to award SaphirKeramik the Swiss Design Prize.

save!
smart
sanitation
for a sustainable
future



INTEGRATED INNOVATION

Human urine is a rich source of phosphorus and nitrogen. These nutrients are valuable raw materials in the production of fertilisers used in agriculture. However, at present, the nutrients in

urine often reach the natural waters directly, going through the wastewater treatment plants largely untreated.

When introduced into the water system, nutrients such as nitrogen and phosphorus do exactly what they do on land: they promote plant growth, contributing to algae bloom and, subsequently, to the formation of the so-called „dead zones“. This has an impact on biodiversity and the health of marine systems, as well as on the economy, particularly fisheries and tourism.

In times of increasingly scarce resources and dwindling raw materials, it is well worth considering urine as a resource rather than letting it go wasted in the sewage system.

SOURCE SEPARATION TECHNOLOGY

If the waste streams are separated as soon as they are produced, they can be processed more sustainably in order to recover valuable resources, and wastewater management becomes part of the circular economy.

In addition to that, the effort required at the wastewater treatment plants is reduced immensely, as 1.5 litres of human urine currently contaminate approx. 180 litres of wastewater.



URINE TRAP

INVISIBLE INNOVATION

Together with Austrian design studio EOOS and the Swiss research institute Eawag, LAUFEN developed a ground-breaking urine separation toilet that opens a new chapter in sustainable wastewater management: “save!”.

The key innovation in “save!” is the urine trap, created by EOOS Design. It uses the hydrodynamic principle of the tea-pot effect to conduct the urine towards a concealed outlet using only surface tension.

The intelligent design of the ceramic body ensures that the urine separation occurs irrespective of whether the toilet is used by a man, a woman or a child.

Rimless and wall-mounted, “save!” meets all industry standards and therefore compromises neither on comfort, nor on hygiene.



A NEW PARADIGM

THE VISION

The installation of urine separation toilets into hotels, public areas and residential developments will lead to sustainable and energy-saving wastewater management, seamlessly integrated the circular economy by efficiently treating the collected wastewater, recovering and recycling the preserved nutrients.



TRANSFORMATIVE CHANGE

“FINALLY A SANITATION SOLUTION THAT IS FIT FOR THE 21ST CENTURY”.

TOVE LARSEN, PROFESSOR FROM EAWAG'S DEPARTMENT FOR URBAN WATER MANAGEMENT



LAUFEN – THE HISTORY



1892

It was on 4th July 1892 when the success story of the „Tonwarenfabrik LAUFEN“ started with the production of bricks and clinkers. The company was founded by three men: Albert Borer, Johann Spillmann & Joseph Gerster-Roth.



1898

Demand for earthenware increases to a volume that makes the construction of a second factory in LAUFEN necessary. The factory, which started production in 1898 was mainly used for the production of roof tiles and bricks as well as drainage pipes.



1905

A canteen is installed on the premises, where quality meals are offered for the workers at 40 cents.

1924

The acquisition of the Aktienziegelei Allschwil, the chimney production Allschwil and the brick factory Tranzer had a „positive impact on all brickyards in the LAUFEN valley“.

As a result, a third kiln is inaugurated. In the same year, the share capital of the „Tonwarenfabrik LAUFEN“ is increased to 1 Mio Swiss Francs.



1925

Under the directive of Guido Gerster, CEO and member of the supervisory board of the Tonwarenfabrik LAUFEN, the „Aktiengesellschaft für keramische Industrie LAUFEN“ is established on 26th November. Fire clay is introduced, which enables the company to produce washbasins and sinks.



1931–1933

An innovative porcelain-like material is launched under the brand name KILVIT. KILVIT is much stronger than fire clay and the pieces come out completely white and dense.



1934

A factory is built to produce wall tiles from stone ware. Thus turning the „AG für keramische Industrie“ into the first manufacturer of wall tiles in Switzerland and serving the national construction industry during the war years



1938

The production of wall tiles is followed by that of floor tiles. Another factory is built in LAUFEN to produce these floor tiles from stone ware. In a difficult business environment new jobs are created.

1949

After World War II, the Swiss Federal Railways, SBB, turns its attention to the electrification of the vast national railroad network. LAUFEN responds with the production of electro-technical porcelain – mainly insulators – and becomes a strong supplier of SBB.

1952

Within a short period of time, a new factory is constructed in Campo Largo, in the greater Curitiba region, by „AG für



keramische Industrie LAUFEN“ to also manufacture wall and floor tiles in Brazil. The company is registered under the name of INCEPA S.A.

1967

LAUFEN acquires the Vienna-based OESPAG (Österreichische Sanitär-Keramik und Porzellanindustrie AG) with its two Austrian production sites in Gmunden and Wilhelmsburg.

1970

The „Keramik Holding AG LAUFEN“ is founded in response to the organisational structure needed to successfully guide the 4'000 employees at various locations in Switzerland, Austria, Germany, Spain and Brazil.



1971

The progressive development of the company necessitates new headquarters. The appointed architect is Giuseppe Gerster, a grandson of Joseph Gerster, who once founded the company.



1973

„On Saturday 3rd August shortly before 3:00 p.m. a fire had broken out in the floor tile factory belonging to the Tonwarenfabrik LAUFEN AG. It emanated from the oil burner at kiln I. Despite the quick reaction with fire extinguishers, the fire was able to spread out, thus destroying the plant to a great extent.“ [Extract from the media]



1982

Ceramic pressure casting, developed by Keramik LAUFEN over years, is unveiled to the public for the first time in October 1982. A process which sets new standards for the sanitary industry, it enabled LAUFEN first to significantly boost its capacities, its efficiency as well as its range.

1986

Issue of 140 000 share certificates at 650 SFr each.



1990

LAUFEN focuses increasingly on design. Porsche Design is the first internationally renowned name to be consulted.

1997

From 1992 to 1997, the company went into debt through acquisitions and embarked on the restructuring of the group which had been due for years.

1999

LAUFEN becomes part of the ROCA group, and thus belongs to one of the largest and most influential enterprises in the bathroom and sanitary ware industry.



2002

In 2002 LAUFEN launched 'Tam Tam', the world's first standing washbasin, cast in one piece.

The washbasin belongs to the design line ILBAGNOALESSI One by Stefano Giovannoni.



2009

The LAUFEN Forum opens its doors. In addition, the Similar headquarters and production facilities are relocated to LAUFEN. This was the last step in the creation of the Swiss competence centre for bathroom culture in LAUFEN.



2013

With the innovation of „SaphirKeramik“ LAUFEN presents a groundbreaking world novelty and sets a new standard for bathroom design.



Keramik LAUFEN celebrates its 125th anniversary.

LAUFEN – THE DESIGNERS

Andreas Dimitriadis



Andreas Dimitriadis launched platinum-design in 2007. In the heart of Stuttgart, his team of product designers, CAD specialists, and model makers works for international brand manufacturers. platinumdesign stands for premium quality as well as commercially successful and multi-award-winning design.



LIVING SQUARE // LIVING SAPHIRKERAMIK
iF Product Design Award 2012
German Design Award 2013 - Nominee
German Design Award - Special Mention 2013
Design Plus powered by ISH 2013
AiT / Innovationspreis Architektur + Technik
Architectural Products Award (PIA)
IDEA International Design Excellence
GOLD Award 2015

PALACE
Red Dot Product Design Award 2011
German Design Award 2013 - Nominee

FLORAKIDS
iF Product Design Award 2011

EOOS



After their graduation at the University of Applied Arts, Gernot Bohmann, Harald Gründl and Martin Bergmann founded Studio EOOS in Vienna in 1995. While the Austrians' main focus is on premium furniture and product designs for well-known brands, they are also known for their designs of shop and brand spaces. Design is a poetical discipline between archaic and high-tech, without losing sight of the essential. For several years now, the studio has therefore attached great importance to participating in projects with a social and sustainable background.



Black Bee Award 2019
Wallpaper life-enhancer of the year 2020

Stefano Giovannoni

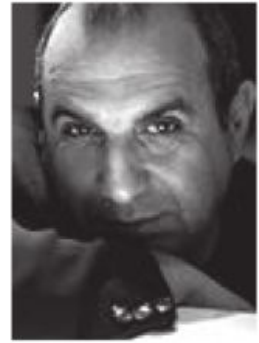

Stefano Giovannoni was born in 1954 in La Spezia, Italy. He studied architecture in Florence. From 1989 onwards, he designed the successful Girotondo accessories collection for Alessi. Today, he lives and works at Studio Giovannoni, on restored former factory premises in the centre of Milan. As well as industrial products, he also designs interiors and architecture.



IL BAGNO ALESSI ONE
Design Plus 2003
Manufacturer Design Awards 2003
Manufacturer Design Awards 2006
Green Good Design Award 2010
Good Design Award 2011
Design Awards 2011
Best of Year (BOY) Awards 2014
ADEX Awards - Platinum Award 2015

Konstantin Grcic



Konstantin Grcic was born in 1965 in Munich, Germany. After training as a cabinetmaker at the John Makepeace School (Dorset, England), he studied industrial design at the Royal College of Art in London. In 1991, Grcic established his studio, Konstantin Grcic Industrial Design (KGID), in Berlin and is now one of the leading industrial designers of the modern era.



VAL
 AIT/Innovationspreis Architektur + Technik 2015
 iF Design Gold Award 2016
 The Architect's Newspaper Best of Product Awards 2016
 Best of Year Awards 2016
 Red Dot Award: Product Design 2017
 Red Dot Award: Product Design 2018

Toan Nguyen



Toan Nguyen was born in Paris in 1969 and graduated from ENSI-Les Ateliers in Paris as an industrial designer. Nguyen gained experience by working in various design offices in Paris, Barcelona, and Madrid before working with Antonio Citterio as a design director and design partner. Toan Nguyen set up his own design studio in Milan in 2008. The Toan Nguyen Studio is multidisciplinary, specialising in design development in various product areas.



INO
 Design Plus powered by ISH 2015
 Designpreis Rheinland-Pfalz
 Best of Year Awards 2015
 AZ Awards 2016 - Award of Merit
ANTERO
 Red Dot Product Design Award 2012
 German Design Award 2014

Ludovica+Roberto Palomba



Ludovica Serafini and Roberto Palomba studied architecture at Rome University. In 1994, they founded their Milan-based company together. They have made a name for themselves with their unconventional interior designs for bathrooms, kitchens, and living spaces. Their concepts unite their intuitive grasp of architecture, lifestyle, and industrial objects to create exceptional designs.



PALOMBA COLLECTION
 Design Plus • Manufacturer Design Awards 2005
 Red Dot Product Design Award 2005 / 2007
 ADI Design Index 2006 • iF Product Design Award 2007 / 2013 • Green Good Design Award 2012 • Best of Year Awards- Honoree
 Interior Innovation Award 2013
 Good Design Award 2013
KARTELL BY LAUFEN
 Wallpaper* 2014 • Casa Vogue, Brazil 2014 • Elle Deco International Design Award 2014 • ADEX Awards 2014 Platinum Award
 Best of Year Awards Winner 2017

LAUFEN – THE DESIGNERS

Phoenix Design



When they founded their company in 1987, Tom Schönherr and Andreas Haug laid the cornerstone of their internationally successful design studio in Stuttgart with offices in Munich and Shanghai, as well as laying the foundations for countless products that have developed into best-sellers. Since then, Phoenix Design has ranked globally as a leading independent design studio for product and interface design, creating products with impressive durability and measurable success.



LIVING CITY
iF Product Design Award 2008
Designpreis Deutschland 2009 - Nomination

Patricia Urquiola



Patricia Urquiola was born in Oviedo, Spain, and now lives and works in Milan. She studied architecture at the Polytechnic University of Madrid and Milan Polytechnic, where she earned her degree in 1989 under the tutorship of Achille Castiglioni. In 2001, Patricia Urquiola opened her own studio, where she concentrates on product design, architecture and interior design.



SONAR
iF Design Award 2018
Best of Year Winner 2018

Marcel Wanders



Marcel Wanders is a leading product and interior design studio located in the creative capital of Amsterdam, with over 1,900 iconic product and interior design experiences all around the globe for private clients and premium brands. Marcel Wanders' 27 years of design are celebrated in some of the most renowned art and design museums around the world.



THE NEW CLASSIC
Red Dot Award: Product Design 2019
iF Product Design Award 2019

Peter Wirz



"Design of the human touch": This is the motto of the Vetica design workshop, which was founded in 1997 and has branches in Lucerne, Taipei, Hamburg, and Hong Kong.

The international team around Swiss designer Peter Wirz, who was born in Brienz in 1960, supports the development processes of industrial products with regard to both form and function, acting as a generator of ideas - going above and beyond pure design, which it sees as an interdisciplinary process in a wider context.



LUFEN PRO
Manufacturer Design Awards 2004
Universal Design Award 2011
Universal Design Consumers Favorite 2011
Red Dot Product Design Award 2014

CLEANET RIVA
Red Dot Award: Product Design 2016
Design Plus powered by ISH 2017
iF Product Design Award 2017
Home & Trend Award 2017

LAUFEN – THE REFERENCES IN RENOWNED ARCHITECTURE WORLDWIDE.



The Public Hotel Bespoke washbasin — Herzog & de Meuron Solid surface
New York / USA Architect: Herzog & de Meuron



Mondrian Doha Bespoke bathtub — Marcel Wanders Solid surface
 Doha / Qatar Interior architect: Marcel Wanders



The Tortue Hotel Kartell by Laufen — Ludovica & Roberto Palomba SaphirKeramik
 Hamburg / Germany Interior architect: Kate Hume



Richter Hotel Moskow — Sonar, Val, Palomba SaphirKeramik, solid surface
 Moskow / Russia Architect: Arthur Makarov Designer: Serdar Yanikov



BBC Television Center 689 Val washbasin — Konstantin Grcic SaphirKeramik
 London / UK Interior architect: Suzy Hoodless / Architect: AHMM

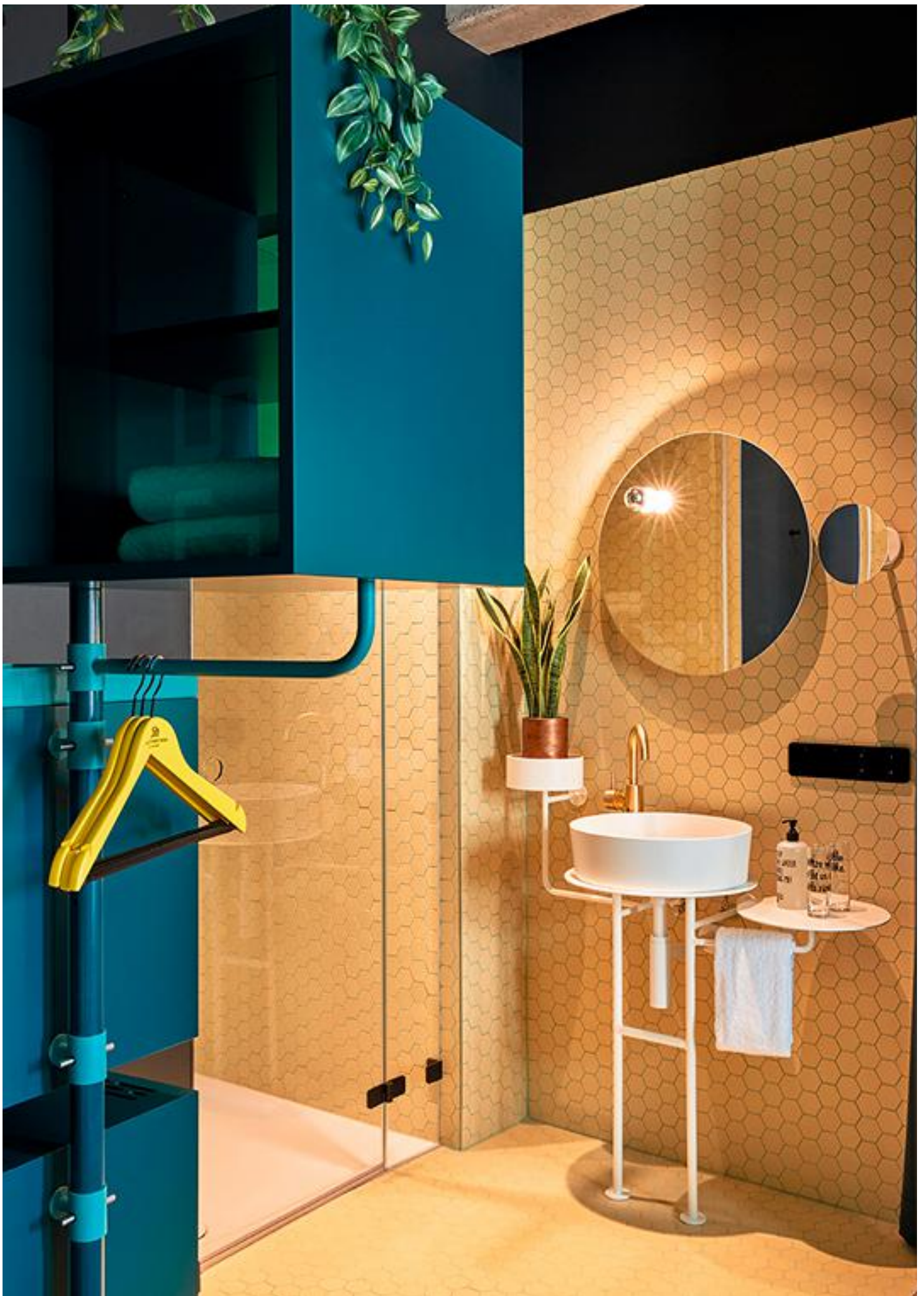

25 Hours Hotel The Circle — Kartell by Laufen — Ludovica & Roberto Palomba — SaphirKeramik
Cologne / Germany Interior architect: Studio Aisslinger

THE NEW CLASSIC Design by Marcel Wanders



THE NEW CLASSIC vanity washbasin 80; vanity unit; tall cabinet; ceramic mirror with LED ambient light; ceramic tooth brush holders; concealed twin handled basin mixer



THE NEW CLASSIC wall-hung toilet ,rimless'; wall-hung bidet; single lever bidet mixer; ceramic toilet brush holder LIS flush plate

THE NEW CLASSIC WASHBASINS WITH FURNITURE / WC / BIDET / BATHTUB / ACCESSORIES

A collection of perfectly shaped innovations for the bathroom. The New Classic radiates the practicality of the harmonious form and combines it with contemporary style. A clear formal expression of modern elegance comes into being which celebrates the bathroom as a place of cleanliness and purity. The award-winning technological quantum leap of SaphirKeramik turns every piece into a witness of progress.



reddot design award
winner 2019

 SaphirKeramik



THE NEW CLASSIC bowl washbasin 55; drawer element; wall-hung WC rimless; ceramic mirror with LED ambient light; ceramic tooth brush holder; ceramic toilet brush holder LIS flush plate

THE NEW CLASSIC



THE NEW CLASSIC freestanding bathtub; concealed single lever bath mixer; wall mounted spout



THE NEW CLASSIC small washbasin 50, undersurface ground; drawer element, ceramic mirror with LED ambient light; ceramic tooth brush holder and soap dish; single lever basin mixer



THE NEW CLASSIC vanity washbasin 120; vanity unit; tall cabinet; wall-hung WC ,rimless'; ceramic mirror with LED ambient light; ceramic toilet brush holder LIS flush plate



THE NEW CLASSIC small washbasin 50; ceramic mirror with LED ambient light; ceramic tooth brush holder and soap dish; single lever basin mixer



THE NEW CLASSIC vanity washbasin 80 with washbasin frame; ceramic mirror with LED ambient light; ceramic tooth brush holder and soap dish; 3-hole basin mixer

THE NEW CLASSIC



THE NEW CLASSIC vanity unit with drawer detail



THE NEW CLASSIC vanity washbasin 120 with vanity unit and set of adjustable feet; ceramic mirror with LED ambient light; single lever basin mixer



THE NEW CLASSIC floorstanding WC ,rimless' with cistern, ceramic toilet brush holder



THE NEW CLASSIC freestanding bathtub



THE NEW CLASSIC bowl washbasin 55; drawer element with set of adjustable feet; ceramic mirror with LED ambient light; wall-hung WC ,rimless"; ceramic toilet brush holder; column single lever basin mixer LIS flush plate

THE NEW CLASSIC



Small washbasin / Small washbasin, undersurface ground

500 x 450 x 135 mm

H815852 / H816852



Vanity washbasin

600 x 480 x 75 mm

H813853



Vanity washbasin

800 x 480 x 75 mm

H813855



Vanity washbasin

1200 x 480 x 75 mm

H813858



UNIVERSAL

Floorstanding cistern, side water inlet (left or right) / rear water inlet (left top) / water inlet on the left side or at the bottom / on the right side or at the bottom

400 x 140 x 980 mm

H828660 / H828661 / H828663 / H828664



Floorstanding WC, close-coupled, washdown, rimless, outlet horizontal or vertical

700 x 370 x 430 mm

H824858



Cistern, rear water inlet (centre) / side water inlet (left or right) / bottom left / bottom right

365 x 150 x 395 mm

H828851 / H828852 / H828853 / H828855



WC seat and cover, removable, with lowering system

H891851



Vanity unit, 1 drawer, matches vanity washbasin 813853

575 x 315 x 345 mm

H406031



Vanity unit, 1 drawer, matches vanity washbasin 813855

575 x 315 x 675 mm

H406041



Vanity unit, 1 drawer, matches vanity washbasin 813858

775 x 315 x 345 mm

H406051



Vanity unit, 2 drawers, matches vanity washbasin 813853

775 x 315 x 675 mm

H406032



Drawer element 800, 1 drawer, with centre cut-out, matches small washbasin 816852

775 x 455 x 345 mm

H406013



Drawer element 800, 2 drawers, matches small washbasin 816852

775 x 455 x 600 mm

H406014



Drawer element 1200, 1 drawer, with centre cut-out, matches small washbasin 816852

1175 x 455 x 345 mm

H406023



Drawer element 1200, 1 drawer, cut-out left / right, matches small washbasin 816852

1175 x 455 x 600 mm

H406085 / H406086

For more details see separately available technical catalogue

THE NEW CLASSIC



Bowl washbasin, oval

550 x 380 x 145 mm

H812852 / H812853



Wall-hung WC, washdown, rimless

530 x 370 x 430 mm

H820851



Floorstanding WC, washdown, rimless, outlet horizontal or vertical

560 x 370 x 430 mm

H823851



UNIVERSAL

Floorstanding cistern, two-part, side water inlet (left or right) / rear inlet (left top) / inlet on the left side or at the bottom / inlet on the right side or at the bottom

400 x 140 x 980 mm

H829660 / H829661 / H829663 / H829664



Wall-hung bidet

530 x 370 x 430 mm

H830851



Floorstanding bidet

560 x 370 x 430 mm

H832851

Colours **Ceramic***



.000
Pergamon



.400
White with LCC (LAUFEN Clean Coat)



.757
White matt

* not all models are available in all colors. More details on the technical pages or on our website.



Vanity unit, 2 drawers, matches vanity washbasin 813855

1175 x 315 x 345 mm

H406042



Vanity unit, 2 drawers, matches vanity washbasin 813858

1175 x 315 x 675 mm

H406052



Drawer element 600, 1 drawer, with centre cut-out, matches small washbasin 816852

575 x 455 x 345 mm

H406003



Drawer element 600, 2 drawers, matches small washbasin 816852

575 x 455 x 600 mm

H406004



Drawer element 1200, 2 drawers, matches small washbasin 816852

1175 x 455 x 345 mm

H406024



Drawer element 1200, 2 drawers, cut-out left / right, matches small washbasin 816852

1175 x 455 x 600 mm

H406087 / H406088



Drawer element 600, 1 drawer, with centre cut-out, matches bowl washbasins 812852, 812853

575 x 455 x 345 mm

H406001



Drawer element 600, 2 drawers, matches bowl washbasins 812852, 812853

575 x 455 x 600 mm

H406002

For more details see separately available technical catalogue

THE NEW CLASSIC



Drawer element 800, 1 drawer, with centre cut-out, matches bowl washbasins 812852, 812853
775 x 455 x 345 mm

H406011



Drawer element 800, 2 drawers, matches bowl washbasins 812852, 812853
775 x 455 x 600 mm

H406012



Drawer element 1200, 1 drawer, with centre cut-out, matches bowl washbasins 812852, 812853
1175 x 455 x 345 mm

H406021



Drawer element 1200, 1 drawer, cut-out left / right, matches bowl washbasins 812852, 812853
1175 x 455 x 600 mm

H406081 / H406082



Washbasin frame, matching vanity washbasin 813853

580 x 320 x 830 mm

H406071



Washbasin frame, matching vanity washbasin 813855

780 x 320 x 830 mm

H406072



Washbasin frame, matching vanity washbasin 813858

1180 x 320 x 830 mm

H406073

Colours **Washbasin frame**



.629
Walnut



Ceramic mirror with LED ambient light

500 x 80 x 700 mm

H406070



Ceramic shelf

420 x 160 mm

H877851



Ceramic toilet brush holder, incl. toilet brush

105 x 95 x 125 mm

H873852



Ceramic tooth brush holder, incl. mounting material

145 x 125 x 145 mm

H873854

THE NEW CLASSIC



Drawer element 1200, 2 drawers, matches bowl washbasins 812852, 812853

1175 x 455 x 345 mm

H406022



Drawer element 1200, 2 drawers, cut-out left / right, matches bowl washbasins 812852, 812853

1175 x 455 x 600 mm

H406083 / H406084



Tall cabinet, 1 door, left / right hinged, with 1 wooden shelf and 4 glass shelves

330 x 330 x 1600 mm

H406061 / H406062

Colours Furniture

-  **.631**
White glossy
-  **.627**
Traffic Grey
-  **.628**
Blacked Oak





Set of adjustable feet (2 pieces), height 165 mm, lacquered metal

165 mm

H406074

Colours Handles / Feets

-  **.631**
White glossy
-  **.170**
White Matt



Freestanding bathtub, made of solid surface material Sentec

1900 x 900 mm

H220852

Colours Bathtubs

-  **.000**
White



Ceramic soap dish

140 x 115 x 35 mm

H873856





Ceramic soap dispenser

180 x 125 x 145 mm

H873855

Colours Ceramic Accessoires

-  **.000**
White
-  **.757**
White matt

Matching countertops can be found in the SPACE / CASE / BOUTIQUE chapters.
Matching furniture can be found in the BOUTIQUE chapter.
Matching mirrors and mirror cabinets can be found in the FRAME 25 / LEELO chapters.
Matching shower toilets can be found in the CLEANET SHOWER TOILETS chapter.

SONAR Design by Patricia Urquiola

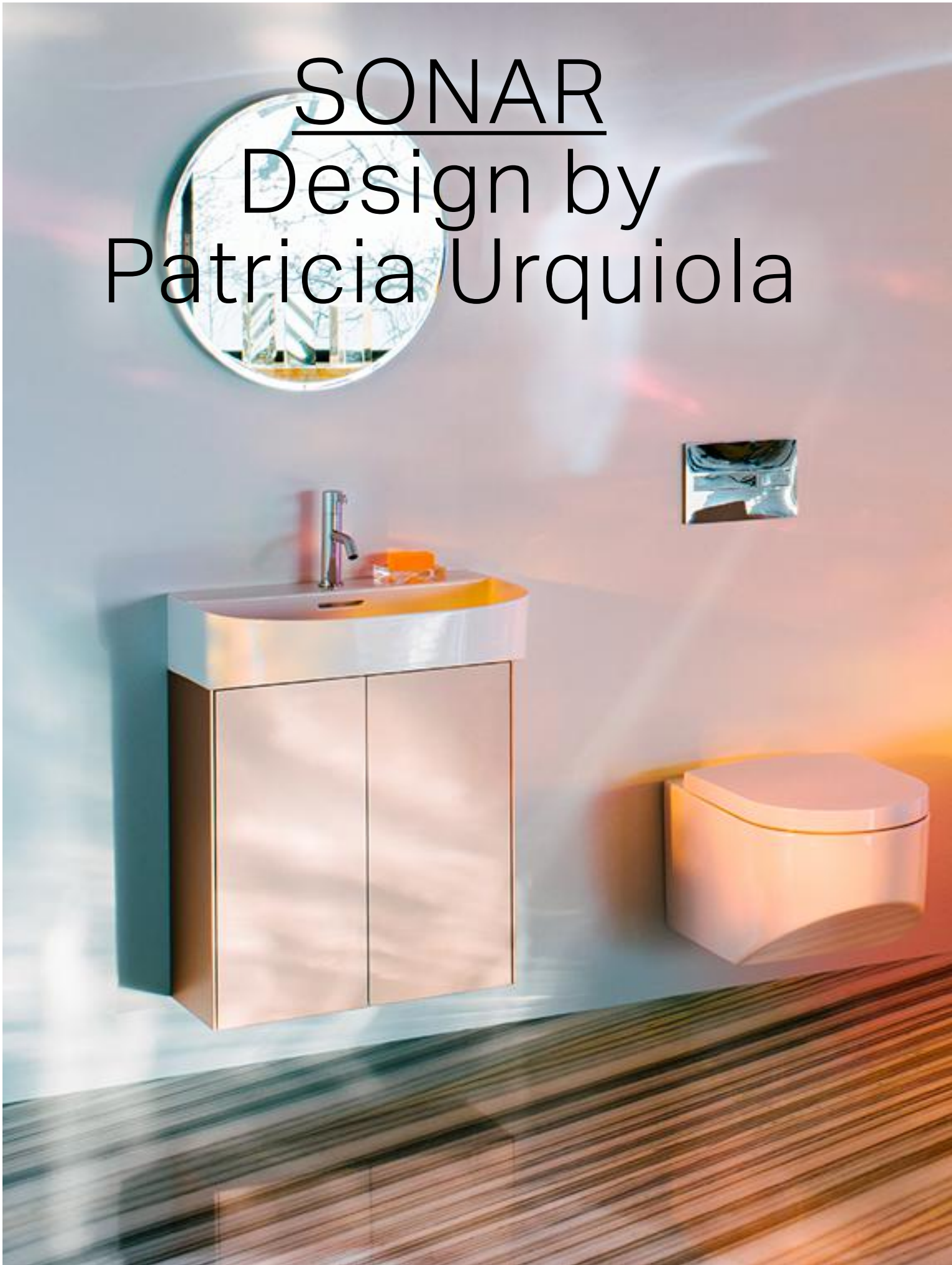

SONAR washbasin 60 with vanity unit; wall-hung WC; freestanding bathtub with tap bank and surface structure; backrest, tray for Sonar bathtubs
KARTELL BY LAUFEN basin mixer; bath mixer; soap dish „Boxy“ FRAME 25 mirror round



SONAR SAPHIRKERAMIK

Patricia Urquiola exploits the fineness of LAUFEN's SaphirKeramik. The designer uses the probably biggest material evolution since the invention of the ceramic material for spectacular elegance in the SONAR series. Accentuated geometry and sensual textures draw a dimension that stimulates even the water to new momentum.



 SaphirKeramik



SONAR bowl washbasin 34; drawer element; wall-hung WC and bidet; tall cabinet LIS flush plate KARTELL BY LAUFEN concealed basin mixer; bidet mixer
FRAME 25 mirror round

SONAR



SONAR double washbasin bowl with surface structure 100, drawer element; tall cabinet; floorstanding WC 'rimless' with floorstanding cistern, two-part
KARTELL BY LAUFEN concealed washbasin mixers FRAME 25 mirror round



SONAR washbasin 60; vanity unit KARTELL BY LAUFEN single lever basin mixer in special colour



SONAR bathtub with backrest

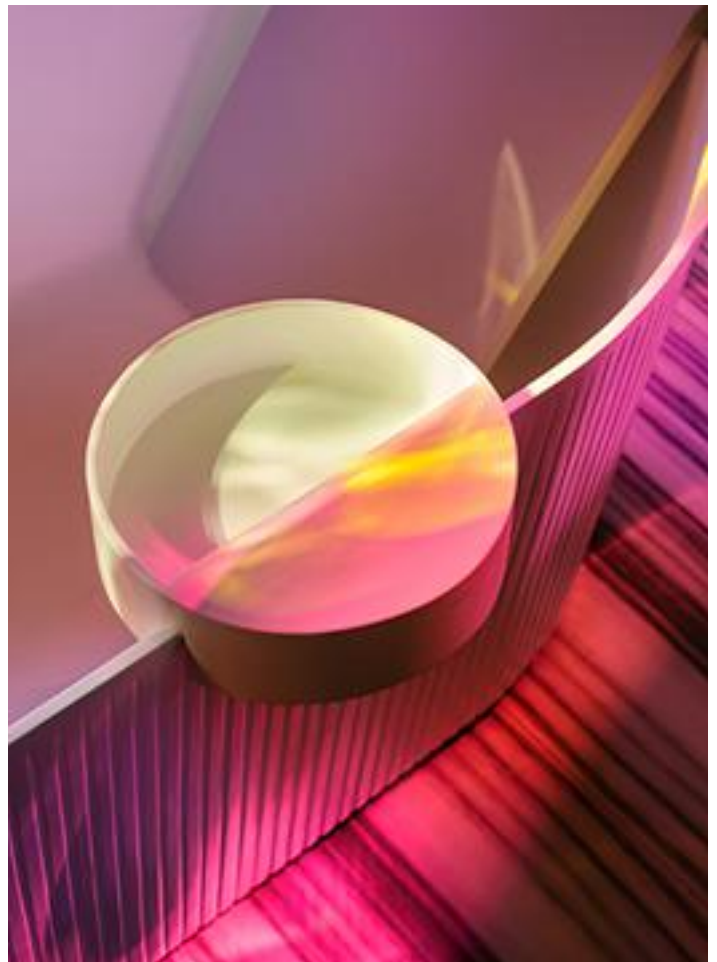

SONAR tray for bathtubs

SONAR

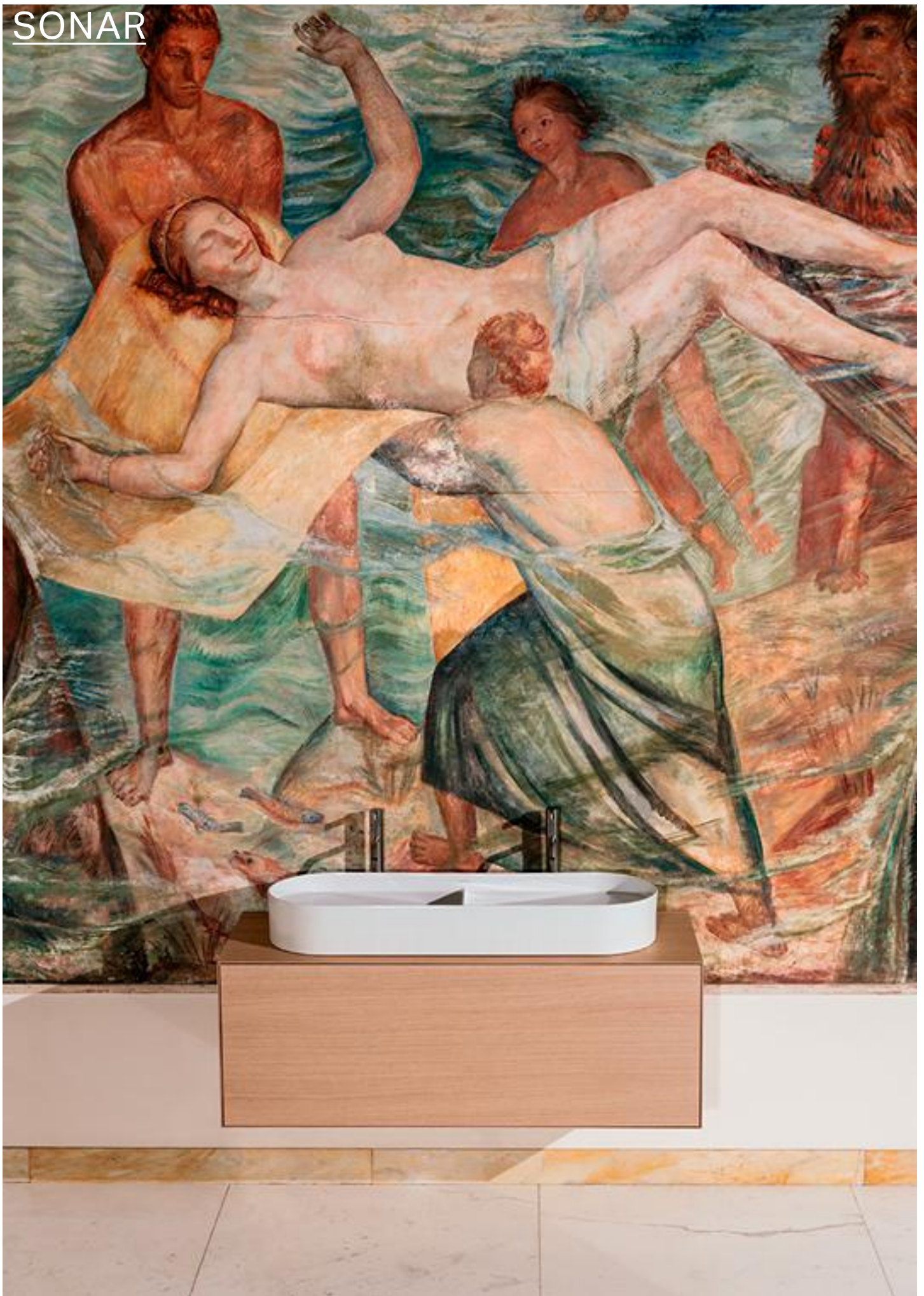

SONAR double bowl washbasin with surface structure BOUTIQUE drawer element KARTELL BY LAUFEN column basin mixers in special colour



SONAR Double bowl washbasin with surface structure
KARTELL BY LAUFEN column basin mixer



SONAR double bowl washbasin without / with surface structure



SONAR Bathtub, made of Sentec solid surface, with wall connection KARTELL BY LAUFEN bath mixer

SONAR



Small washbasin / Small washbasin, undersurface ground, incl. ceramic waste cover

410 x 420 x 140 mm

H815341 / H816341



Washbasin / Washbasin, undersurface ground

600 x 420 x 140 mm

H810342 / H816342



Washbasin / Washbasin, undersurface ground

1000 x 420 x 140 mm

H810347 / H816347



Bowl washbasin without / with surface structure, incl. ceramic waste cover

340 x 340 x 130 mm

H812340 / H812341



Floorstanding WC, washdown, rimless, outlet horizontal or vertical

530 x 370 x 430 mm

H823341



UNIVERSAL

Floorstanding cistern, two-part, side water inlet (left or right) / rear inlet (left top) / inlet on the left side or at the bottom / inlet on the right side or at the bottom

400 x 140 x 980 mm

H829660 / H829661 / H829663 / H829664



UNIVERSAL

Floorstanding cistern, side water inlet (left or right) / rear water inlet (left top) / water inlet on the left side or at the bottom / on the right side or at the bottom

400 x 140 x 980 mm

H828660 / H828661 / H828663 / H828664



WC seat and cover, removable, with lowering system

H893341



Wall-hung bidet

530 x 370 x 340 (430) mm

H830341



Drawer element, 1 drawer, matching bowl washbasins 812340, 812341, 812342, 812343, centre cut-out

575 x 455 x 340 mm

H405401



Drawer element, 1 drawer, matching bowl washbasins 812340, 812341, 812342, 812343, centre cut-out

775 x 455 x 340 mm

H405411



Drawer element, 1 drawer, matching bowl washbasins 812340, 812341, 812342, 812343, centre cut-out

1175 x 455 x 340 mm

H405421



Drawer element, 1 drawer, matching bowl washbasins 812340, 812341, 812342, 812343, centre cut-out incl. drilled tap hole

1175 x 455 x 340 mm

H405425



Drawer element, 1 drawer, matching bowl washbasins 812340, 812341, 812342, 812343, cut-out left / right, incl. drilled tap hole

1175 x 455 x 340 mm

H405426 / H405427



Drawer element, 1 drawer, matching bowl washbasins 812340, 812341, 812342, 812343, cut-outs left and right incl. drilled tap holes

1175 x 455 x 340 mm

H405428



Drawer element, 1 drawer, matching small washbasin 816341, centre cut-out

575 x 455 x 340 mm

H405431

For more details see separately available technical catalogue



Bowl washbasin without / with surface structure, incl. ceramic waste cover

410 x 365 x 130 mm

H812342 / H812343



Double bowl washbasin without / with surface structure, incl. ceramic waste cover

1000 x 370 x 130 mm

H812348 / H812349



Washbasin with integrated pedestal, without tap bank, with wall connection, incl. ceramic waste cover

410 x 380 x 900 mm

H811341



Wall-hung WC, washdown, rimless

530 x 370 x 340 (430) mm

H820341

Colours Ceramic*



.000
White



.400
White with LCC (LAUFEN Clean Coat)



.757
White matt

* not all models are available in all colors. More details on the technical pages or on our website.



Drawer element, 1 drawer, matching bowl washbasins 812340, 812341, 812342, 812343, cut-out left / right

1175 x 455 x 340 mm

H405422 / H405423



Drawer element, 1 drawer, matching bowl washbasins 812340, 812341, 812342, 812343, cut-outs left and right

1175 x 455 x 340 mm

H405424



Drawer element, 1 drawer, matching bowl washbasins 812340, 812341, 812342, 812343, centre cut-out incl. drilled tap hole

575 x 455 x 340 mm

H405405



Drawer element, 1 drawer, matching bowl washbasins 812340, 812341, 812342, 812343, centre cut-out incl. drilled tap hole

775 x 455 x 340 mm

H405415



Drawer element, 1 drawer, matching washbasins 816341, 816342, centre cut-out

775 x 455 x 340 mm

H405441



Drawer element, 1 drawer, matching washbasins 816341, 816342, centre cut-out

1175 x 455 x 340 mm

H405451



Drawer element, 1 drawer, matching washbasins 816341, 816342, cut-out left / right

1175 x 455 x 340 mm

H405452 / H405453



Drawer element, 1 drawer, matching small washbasin 816341, cut-out left and right

1175 x 455 x 340 mm

H405454

For more details see separately available technical catalogue

SONAR



Drawer element, 1 drawer, matching washbasin undersurface ground 816347, centre cut-out
1175 x 455 x 340 mm

H405461



Drawer element, 1 drawer, matching washbasin bowls 812348, 812349, centre cut-out
1175 x 455 x 340 mm

H405471



Vanity unit, 1 door, left / right hinged, matching small washbasin 815341

385 x 240 x 600 mm

H405481 / H405482





Vanity unit, 2 doors, matching washbasin 810342

580 x 240 x 600 mm

H405483

Colours Towel holder CASE

-  **.104**
Anodised aluminium, glossy
-  **.105**
Anodised aluminium
-  **.106**
Anodised aluminium, dark brown



CASE

Towel holder for furniture, 270 / 320 mm

270 / 320 x 60 x 15 mm

H490950 / H490951



Freestanding bathtub with tap bank and surface structure, made of Marbond composite material

1600 x 815 mm

H221342



Bathtub, made of Sentec solid surface, with wall connection, tap bank and integrated overflow

1600 x 815 mm

H220347



Backrest, light grey

400 x 90 x 625 mm

H292340



Tray for Sonar bathtubs

265 x 265 x 80 mm

H293340



Vanity unit, 2 doors, matching washbasin 810347

975 x 240 x 600 mm

H405484







Tall cabinet, 1 door, left / right hinged, with 1 wooden shelf and 4 glass shelves

320 x 320 x 1595 mm

H405491 / H405492

Colours Furniture*

-  **.040**
Gold
-  **.041**
Copper
-  **.042**
Titanium
-  **.140**
Gold & nero marquina
-  **.141**
Copper & nero marquina
-  **.142**
Titanium & nero marquina

* not all models are available in all colors. More details on the technical pages or on our website.

Colours Bathtubs

-  **.000**
White

Matching mirrors and mirror cabinets can be found in the FRAME 25 / LEELO chapters.
Matching furniture can be found in the BOUTIQUE chapter.
Matching shower toilets can be found in the CLEANET SHOWER TOILETS chapter.

IL BAGNO **ALESSI** One Design by Stefano Giovannoni



IL BAGNO ALESSI ONE vanity washbasin 90; wall-hung WC 'rimless'; wall-hung bidet; freestanding bathtub; vanity unit 120; mirror; toilet roll holder



ILBAGNOALESSI ONE

Italian architect and designer Stefano Giovannoni breaks out. From the repetition of form of room geometry, which only ever produces the same templates. He leaves worn stereotypes behind and combines the extraordinary with the popular. Well-known structural frameworks suddenly evoke irregular, subtle associations that dissolve the principles of perception and open up new spatial worlds. However, the newly conceived contours of the Italian architect and designer are not only reflected in the first complete bathroom scenario for ILBAGNOALESSI ONE. They are also knighted by the exhibition in the permanent collections of the Centre Georges Pompidou in Paris and the Museum of Modern Art in New York.



DESIGN **PLUS**



BEST
OF
YEAR
HONOREE
2014





ILBAGNOLESSI ONE vanity washbasin 160; wall-hung WC 'rimless'; wall-hung bidet; vanity unit; mirror; toilet paper holder; towel hook; shelf
KARTELL BY LAUFEN faucets

ILBAGNOALESSI ONE



ILBAGNOALESSI ONE vanity washbasin 90; vanity unit



ILBAGNOLESSI ONE freestanding washbasin; floorstanding WC; floorstanding bidet



ILBAGNOLESSI ONE freestanding bathtub



ILBAGNOLESSI ONE washbasin with wall connection; urinal with cover; mirror



ILBAGNOLESSI ONE Wall-hung WC ,rimless'

ILBAGNOALESSI ONE



ILBAGNOALESSI ONE vanity washbasin 120; vanity unit



ILBAGNOALESSI ONE tall cabinet with mirror



ILBAGNOALESSI ONE high bowl washbasin



IBAGNOLESSI ONE vanity unit with drawer; organiser



IBAGNOLESSI ONE bowl washbasin with tap bank 75; vanity unit; cover for vanity unit

ILBAGNOALESSI ONE



Vanity washbasin, shelf right, with concealed overflow, incl. ceramic waste cover

900 x 500 x 165 mm

H814975



Vanity washbasin, shelf left, with concealed overflow, incl. ceramic waste cover

900 x 500 x 165 mm

H814976



Vanity washbasin, shelf right, with concealed overflow, incl. ceramic waste cover

1200 x 500 x 165 mm

H814973



Vanity washbasin, shelf left, with concealed overflow, incl. ceramic waste cover

1200 x 500 x 165 mm

H814974



Bowl washbasin with tap bank, with concealed overflow, incl. ceramic waste cover

520 x 520 x 175 mm

H818971



Bowl washbasin, with tap bank, flat, with concealed overflow, incl. ceramic waste cover

750 x 520 x 90 mm

H818972



Bowl washbasin, shelf positionable right or left, incl. ceramic waste cover

800 x 420 x 145 mm

H818973



Wall-hung WC 'rimless', washdown, without flushing rim

585 x 390 x 355 mm

H820971



WC seat and cover, removable, with lowering system

H892971



Wall-hung bidet, with concealed overflow, incl. ceramic waste cover

585 x 390 x 355 mm

H830971



Floorstanding bidet, with concealed overflow, incl. ceramic waste cover

390 x 585 x 415 mm

H832971



Siphonic urinal, internal water inlet, version for cover

325 x 290 x 585 mm

H840971



Bathtub, fitted version, with centre outlet, with frame, made of Sentec solid surface

1780 x 820 mm

H245971



Freestanding bathtub, made of Sentec solid surface, with centre outlet, with lifting system

1830 x 870 mm

H245972



Bathtub, oval, drop-in version, with centre outlet, with frame, sanitary acrylic

2030 x 1020 mm

H243970



Freestanding bathtub, oval, with panel, with centre outlet, sanitary acrylic

2030 x 1020 mm

H241970

For more details see separately available technical catalogue

ILBAGNOALESSI ONE



Vanity washbasin, shelf right, with concealed overflow, incl. ceramic waste cover

1600 x 500 x 165 mm

H814971



Washbasin with integrated pedestal, with wall connection, with concealed overflow, incl. ceramic waste cover

520 x 530 x 850 mm

H811971



Freestanding washbasin, with concealed overflow, incl. ceramic waste cover

530 x 530 x 900 mm

H811972



High bowl washbasin, without overflow, incl. ceramic waste cover

450 x 450 x 400 mm

H811973



Floorstanding WC, washdown, with flushing rim, outlet horizontal/vertical

585 x 390 mm

H821971



Floorstanding WC, close-coupled, washdown, with flushing rim, outlet horizontal/vertical

720 x 390 x 460 mm

H822976



Cistern, rear water inlet (left top)

370 x 160 x 485 mm

H826971



One-piece WC, siphonic action, single flush / dual flush

745 x 405 x 730 mm

H823970 / H823971

Colours Ceramic



.400

White with LCC (LAUFEN Clean Coat)



Siphonic urinal, internal water inlet, version without cover

290 x 325 x 585 mm

H840975



Cover for urinal

H894971

Colours Furniture



.630

Noce canaletto



.631

White glossy



Bathtub, oval, semi-recessed, with half panel, with centre outlet, sanitary acrylic

2030 x 1020 mm

H244970

ILBAGNOALESSI ONE



Vanity unit, 2 drawers, matches washbasin 814976 / 814975

730 x 320 x 475 mm

H424450 / H424470



Vanity unit, 2 drawers, matches washbasin 814974 / 814973

990 x 320 x 485 mm

H424500 / H424520



Vanity unit, 2 drawers, matches washbasin 814971

1350 x 320 x 490 mm

H424360



Vanity unit, 800 mm, centre cut-out, 2 drawers, matches washbasin 818971 / 818972

800 x 500 x 330 mm

H424023 / H424033



Vanity unit, 1600 mm, cut-out left / right, 4 drawers, matches washbasin 818973

1600 x 500 x 330 mm

H424261 / H424262



Cover, 2400 mm, with cut-out left, for two vanity units with wide drawers left, for bowl washbasins 818971/2/3 and 813971

2400 x 500 x 12 mm

H424602 / H424603 / H424604



Cover 2400 mm, with cut-out left, for 2 vanity units with wide drawers right, for bowl washbasins 818971/2/3 and 813971

2400 x 500 x 12 mm

H424612 / H424613 / H424614



Cover 2400 mm, with 2 cut-outs right and left centre, for 1 vanity unit with wide drawers right and for 1 vanity unit with wide drawers left, for bowl washbasins 818971/2/3 and 813971

2400 x 500 x 12 mm

H424624



Tall cabinet, 1 door, left / right hinged, mirrored on both sides, 2 glass shelves, 2 interior drawers

400 x 300 x 1700 mm

H458012 / H458022



Tall cabinet, 1 door, left / right hinged, mirrored on both sides, 4 illuminated glass shelves

400 x 300 x 1700 mm

H458031 / H458041



Tall cabinet, 1 door, left / right hinged, mirrored on both sides, 2 illuminated glass shelves, 2 interior drawers

400 x 300 x 1700 mm

H458032 / H458042



Mirror with integrated lighting, 400 mm, frame and demister (mirror heating)

400 x 60 x 1000 mm

H448411

Colours **Ceramic Accessoires**

.000
White



Ceramic towel holder

130 x 70 x 95 mm

H870976



Ceramic toilet roll holder

185 x 150 x 110 mm

H870970



Ceramic shelf, with towel slot

630 x 175 x 50 mm

H870972

For more details see separately available technical catalogue

ILBAGNOALESSI ONE



Vanity unit, 1200 mm, cut-out left / right, 4 drawers, matches washbasin 818971

1200 x 500 x 330 mm

H424121 / H424122



Vanity unit, 1200 mm, cut-out left / right, 4 drawers, matches washbasin 818972

1200 x 500 x 330 mm

H424131 / H424132



Vanity unit, 1200 mm, cut-out left / right, 3 drawers, matches washbasin 818973

1200 x 500 x 330 mm

H424161 / H424162



Vanity unit, 1600 mm, cut-out left and right, 4 drawers, matches washbasin 818971

1600 x 500 x 330 mm

H424224



Vanity unit, 1200 mm, use only in combination with a top, 4 drawers with wide drawers on the left / right

1200 x 500 x 330 mm

H424170 / H424180



Small organiser for drawer (not suitable for: 424053, 424151, 424152, 424360)

370 x 202 x 45 mm

H492401



Large organiser for drawer (not suitable for: 424053, 424151, 424152, 424360)

370 x 312 x 45 mm

H492402



Tall cabinet, 1 door, left / right hinged, mirrored on both sides, 4 glass shelves

400 x 300 x 1700 mm

H458011 / H458021

Colours **Bathtubs**



.000
White

Mirror with integrated lighting, 800 / 1200 / 1600 mm, frame and demister (mirror heating)

800 / 1200 / 1600 x 60 x 400 mm

H448421 / H448431 / H448441

Colours **Towel holder CASE**



.104
Anodised aluminium, glossy

.105
Anodised aluminium

.106
Anodised aluminium, dark brown

CASE

Towel holder for furniture, 270 / 320 / 400 mm

270 / 320 / 400 x 60 x 15 mm

H490950 / H490951 / H490952

Matching shower toilets
can be found in the
CLEANET SHOWER TOILETS
chapter.

PALOMBA
COLLECTION
Design by
Ludovica+Roberto
Palomba



PALOMBA bowl washbasin 52; freestanding bathtub BOUTIQUE drawer element 90 FRAME 25 mirror 180
KARTELL BY LAUFEN column washbasin mixer; column bath mixer



PALOMBA COLLECTION

Water, as a source of life, represents the source of inspiration for Ludovica and Roberto Palomba. This was noticeable with all senses when the successful PALOMBA COLLECTION from LAUFEN was launched. The intensive connection with the fluid and sparkling element finds its definition in the formal language, which the famous Italian designer duo describes with the expression „fingerprint of nature“. The tension between strict geometry and organic form characterises the entire collection and ensures that all pieces come closer together. In the extension of the PALOMBA COLLECTION, soft, organic lines present themselves as harmonious elements that also enable the most demanding bathroom designs.



reddot design award
winner 2005



reddot design award
winner 2007



product
design
award
2007



product
design
award
2013



MANUFACTURER
AWARDS 2005

interior
innovation
award
2013
Winner



BEST
OF
YEAR HONOREE
2012

DESIGN **PLUS**



PALOMBA COLLECTION freestanding washbasin; freestanding bathtub; floorstanding toilet and bidet

PALOMBA COLLECTION



PALOMBA COLLECTION washbasin 120; vanity unit; wall-hung WC; freestanding bathtub



PALOMBA COLLECTION washbasin 120 with towel rail



PALOMBA COLLECTION wall-hung WC; wall-hung bidet



PALOMBA COLLECTION tall cabinet; medium cabinet



PALOMBA COLLECTION freestanding bathtub

PALOMBA COLLECTION



PALOMBA COLLECTION washbasin with integrated pedestal, with wall connection



PALOMBA COLLECTION double washbasin 160; wall-hung WC; wall-hung bidet; vanity unit 160



PALOMBA COLLECTION bowl washbasin 52



PALOMBA COLLECTION bowl washbasin 60; vanity unit 100
FRAME 25 mirror

PALOMBA COLLECTION



Washbasin, asymmetrical

800 x 500 x 40 mm

H814804



Washbasin, asymmetrical

1200 x 500 x 40 mm

H814806



Washbasin, asymmetrical

1600 x 500 x 40 mm

H814808



Double washbasin

1600 x 500 x 40 mm

H814809



Bowl washbasin

900 x 420 x 160 mm

H816801



Wall-hung WC, rimless, washdown

540 x 360 x 265 (430) mm

H820802



Floorstanding WC, washdown, with flushing rim, outlet horizontal/vertical

360 x 560 x 430 mm

H823806



UNIVERSAL

Floorstanding cistern, two-part, side water inlet (left or right) / rear inlet (left top) / inlet on the left side or at the bottom / inlet on the right side or at the bottom 400 x 140 x 980 mm

H829660 / H829661 / H829663 / H829664

Colours **Ceramic***



.000
White



.400
White with LCC (LAUFEN Clean Coat)

* not all models are available in all colors. More details on the technical pages or on our website.



WC seat and cover, removable, with lowering system

H891802



Wall-hung bidet

540 x 360 x 265 (430) mm

H830801



Floorstanding bidet

560 x 360 x 430 mm

H832801

Colours **Furniture**



.220
White



.222
Cherry Vermont dark



Tall cabinet, 1 door, left / right hinged

360 x 310 x 1650 mm

H406751 / H406752



Medium cabinet, 1 door, left or right hinged

275 x 250 x 825 mm

H406701

For more details see separately available technical catalogue

PALOMBA COLLECTION



Freestanding washbasin

525 x 400 x 900 mm

H811803



Washbasin with integrated pedestal, with wall connection

525 x 435 x 900 mm

H811804



Bowl washbasin

520 x 380 x 130 mm

H816802



Bowl washbasin, with semi-wet area and tap bank

600 x 400 x 130 mm

H816803



UNIVERSAL

Floorstanding cistern, side water inlet (left or right) / rear water inlet (left top) / water inlet on the left side or at the bottom / on the right side or at the bottom
400 x 140 x 980 mm

H828660 / H828661 / H828663 / H828664



Floorstanding WC, close-coupled, washdown, rimless, outlet horizontal or vertical

700 x 360 x 460 (430) mm

H824801



Floorstanding WC, close-coupled, washdown, with flushing rim, outlet horizontal or vertical

700 x 360 x 460 (430) mm

H824806



Cistern, rear water inlet (centre) / side water inlet (left or right) / bottom left / bottom right

345 x 165 x 435 mm

H828801 / H828802 / H828803 / H828805



Towel holder, chromed, matches washbasin 814804 / 814806 / 814808 / 814809

760 x 25 x 95 mm

H381801



Towel holder, chromed, matches washbasin 814804 / 814806 / 814808 / 814809

1160 x 25 x 95 mm

H381802



Towel holder, chromed, matches washbasin 814804 / 814806 / 814808 / 814809

1560 x 25 x 95 mm

H381803



Towel holder, chromed, matches washbasin 814804 / 814806 / 814808 / 814809

1560 x 25 x 95 mm

H381804

PALOMBA COLLECTION



Vanity unit, 2 drawers, matches washbasin 814804

785 x 495 x 590 mm

H407202



Vanity unit, 4 drawers, matches vanity washbasin 814806

1185 x 495 x 590 mm

H407304



Vanity unit, 4 drawers, matches vanity washbasin 814808

1585 x 495 x 590 mm

H407404





Vanity unit, 4 drawers, matches vanity washbasin 814809

1585 x 495 x 590 mm

H407454

Colours **Towel holder CASE**

-  **.104**
Anodised aluminium, glossy
-  **.105**
Anodised aluminium
-  **.106**
Anodised aluminium, dark brown



CASE

Towel holder for furniture, 270 / 320 / 400 mm

270 / 320 / 400 x 60 x 15 mm

H490950 / H490951 / H490952



Freestanding bathtub, with panel and centre outlet, sanitary acrylic

1800 x 900 mm

H231800



Bathtub, drop-in version, with centre outlet, rim 40 mm, sanitary acrylic

1800 x 900 mm

H232800 / H232801

PALOMBA COLLECTION

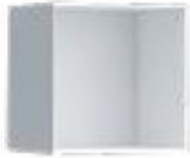

Square box

275 x 220 x 275 mm

H407001



Rectangular box

550 x 220 x 275 mm

H407101



Rectangular box with 1 glass shelf

275 x 220 x 550 mm

H407102 / H407103



Organiser for drawer, glass

120 x 295 x 64 mm

H490301



Bathtub, drop-in version, rim 20 mm, sanitary acrylic

1800 x 800 mm

H242800 / H242801



Bathtub, drop-in version / with frame, rim 80 mm, sanitary acrylic

1800 x 800 mm

H243800 / H243801



Freestanding bathtub, made of Sentec solid surface

1800 x 890 mm

H245802

Colours **Bathtubs**

.000
White

Matching mirrors and mirror cabinets can be found in the FRAME 25 / LEELO chapters.
Matching shower toilets can be found in the CLEANET SHOWER TOILETS chapter.

Kartell by LAUFEN

Design by
Ludovica+Roberto
Palomba

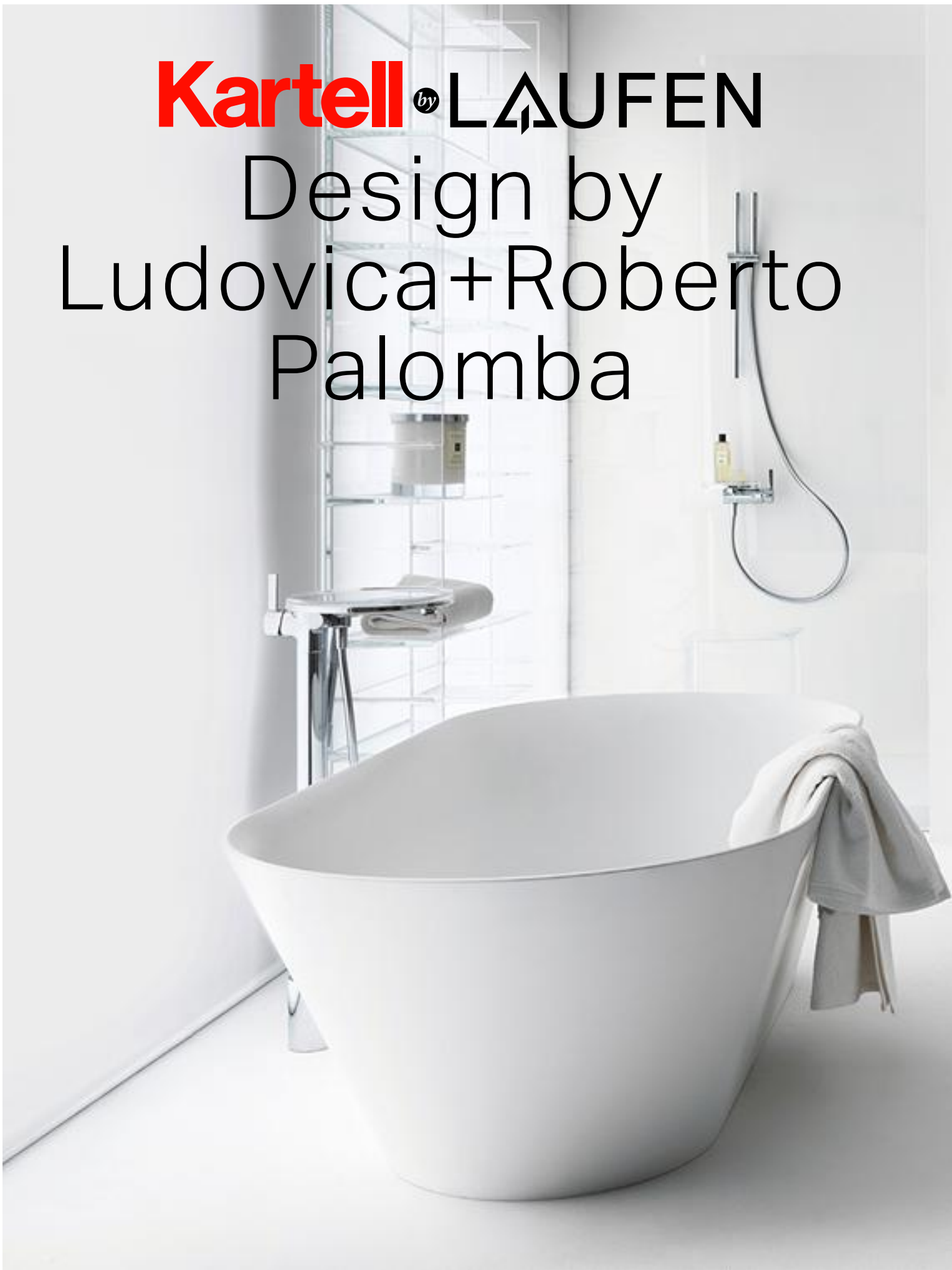

KARTELL BY LAUFEN freestanding bathtub; column bath mixer; shower mixer; shelf 'Sound-rack'



KARTELL BY LAUFEN combipack washbasin 'slim' with vanity unit, 60; side element; washbasin mixer; 'Rifly' wall light FRAME 25 mirror

KARTELL BY LAUFEN

Ludovica and Roberto Palomba continue to play off the strengths of the Kartell by Laufen range of icons with the greatest of ease, lending physical form to the endless options available by combining colours, forms and surfaces. New washbasin creations of this design classic in an extremely compact form and created from revolutionary SaphirKeramik. For your own freedom in bathroom design. For decisions with sense and feeling. For an unparalleled amount of space. For tangible quality that leaves nothing to be desired.





KARTELL BY LAUFEN freestanding washbasin with special decor; washbasin mixer in special colour; 'All Saints' mirror

KARTELL BY LAUFEN



KARTELL BY LAUFEN combipack washbasin 'slim' with vanity unit, 100; washbasin mixer; 'All Saints' mirror; 'Max-Beam' stool; towel holder 'Rail' 60



KARTELL BY LAUFEN tall cabinet right hinged



KARTELL BY LAUFEN Washbasin 45; washbasin mixer; vanity unit; 'All Saints' mirror; tumbler 'Boxy'; towel holder 'Rail'



KARTELL BY LAUFEN combipack washbasin 'slim' with vanity unit, 60



KARTELL BY LAUFEN washbasin, 60, washbasin mixer BOUTIQUE countertop made to measure + floorstanding drawer element

KARTELL BY LAUFEN



KARTELL BY LAUFEN bowl washbasin 42; wall basin mixer VAL storage tray, rectangular



KARTELL BY LAUFEN freestanding washbasin 37; basin mixer in special colour; 'All Saints' mirror



KARTELL BY LAUFEN washbasin 60; basin mixer in special colour; 'All Saints' mirror



KARTELL BY LAUFEN small washbasin 46 with frame; basin mixer; mirror ,All Saints'; stool ,Max-Beam'; shelf ,Sound-rack'; pendant light ,Rifty' with basin mixer; ,All Saints' mirror; ,Max-Beam' stool; ,Sound-rack' shelf



KARTELL BY LAUFEN Washbasin 90; washbasin mixer; vanity unit; tumbler ,Boxy'; soap dish ,Boxy'



KARTELL BY LAUFEN Small washbasin 46; washbasin mixer; vanity unit; mirror ,All saints'; pendant lamp ,Rifty'; stool ,Max Beam';



KARTELL BY LAUFEN Washbasin 60; washbasin mixer; vanity unit; shelf ,Sound-rack'; mirror ,All saints'; towel holder ,Rail'; stool ,Max Beam' CLEANET RIVA Shower toilet

KARTELL BY LAUFEN



KARTELL BY LAUFEN washbasin 120, shelf right; basin mixer in special colour; vanity unit; tall cabinet; mirror ‚All saints‘; stool ‚Max Beam‘



KARTELL BY LAUFEN freestanding washbasin; 2-hole basin mixer; tall cabinet; shelf ,Shellfish'; towel holder ,Rail' 60; stool ,Max-Beam'; mirror ,All Saints'



KARTELL BY LAUFEN washbasin 60; washbasin mixer; vanity unit; shelf ,Sound-rack'; mirror ,All Saints'; towel holder ,Rail'



KARTELL BY LAUFEN washbasin 120, shelf right; basin mixer ,disc' with tray; stool ,Max-Beam' BOUTIQUE drawer element 90 FRAME 25 mirror 60



KARTELL BY LAUFEN wall-hung WC 'rimless'; wall-hung bidet; bidet mixer with tray; toilet paper holder with tray; towel holder 'Rail'

KARTELL BY LAUFEN



KARTELL BY LAUFEN washbasin 50; basin mixer in special colour; tumbler ,Boxy'



KARTELL BY LAUFEN washbasin 50; basin mixer in special colour; tumbler ,Boxy'



KARTELL BY LAUFEN bowl washbasin with tap bank 75; basin mixer ‚disc‘ with tray; mirror ‚All Saints‘



KARTELL BY LAUFEN washbasin 90; basin mixer in special colour; vanity unit; tall cabinet; mirror ‚All Saints‘



Coloured lighting stimulates all the senses. LAUFEN offers two different types of lighting: Underwater LED lamps light up the water or an LED strip in the slot overflow (found in the Kartell by Laufen bathtubs) creating a relaxing atmosphere. Normally, the colour of the LED lights constantly changes, but you also have the option of selecting one colour using the sensor control system.

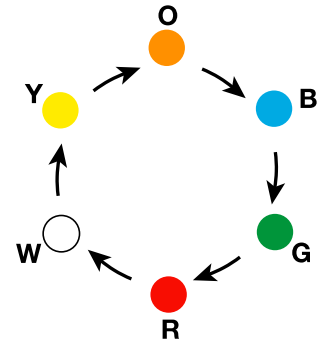

KARTELL BY LAUFEN



Small washbasin, tap bank right / left, with concealed outlet

460 x 280 x 120 mm
H815334 / H815335



Small washbasin with concealed outlet / undersurface ground

460 x 460 x 120 mm
H815331 / H818331



Washbasin / Washbasin, undersurface ground

500 x 460 x 145 mm
H810332 / H816332



Washbasin / Washbasin, undersurface ground

600 x 460 x 120 mm
H810333 / H816333



Washbasin, shelf right, with concealed outlet

1200 x 460 x 120 mm
H813332



Washbasin, shelf left, with concealed outlet

1200 x 460 x 120 mm
H813333



Combipack 500 mm, washbasin 'slim' with vanity unit with 2 drawers, incl. drawer organiser

500 x 500 x 725 mm
H860331



Combipack 600 mm, washbasin 'slim' with vanity unit with 2 drawers, incl. drawer organiser

600 x 500 x 725 mm
H860333

Colours Washbasin frame



Bowl washbasin

420 x 420 x 120 mm
H812331



Bowl washbasin with tap bank, with concealed outlet

750 x 350 x 120 mm
H812332



Wall-hung WC 'rimless', washdown, without flushing rim

545 x 370 x 355 mm
H820337



UNIVERSAL

Floorstanding cistern, side water inlet (left or right) / rear water inlet (left top) / water inlet on the left side or at the bottom / on the right side or at the bottom

400 x 140 x 980 mm
H828660 / H828661 / H828663 / H828664



Floorstanding WC, close-coupled, washdown, rimless

660 x 370 x 440 (430) mm
H824331



Floorstanding WC 'rimless', close-coupled, washdown, without flushing rim

660 x 370 x 430 mm
H824337



Cistern, rear water inlet (centre) / side water inlet (left or right) / bottom left / bottom right

370 x 150 x 395 mm
H829331 / H829332 / H829333 / H829335

For more details see separately available technical catalogue



Washbasin, shelf right, with concealed outlet / undersurface ground

600 x 460 x 120 mm

H810334 / H818334



Washbasin, shelf left, with concealed outlet / undersurface ground

600 x 460 x 120 mm

H810335 / H818335



Washbasin, shelf right, with concealed outlet / undersurface ground

900 x 460 x 120 mm

H810338 / H818338



Washbasin, shelf left, with concealed outlet / undersurface ground

900 x 460 x 120 mm

H810339 / H818339



Combipack 800 mm, washbasin, 'slim' with vanity unit with 2 drawers, incl. drawer organiser

800 x 500 x 725 mm

H860335



Combipack 1000 mm, washbasin, 'slim' with vanity unit with 2 drawers, incl. drawer organiser

1000 x 500 x 725 mm

H860337



Freestanding washbasin with concealed outlet

375 x 435 x 900 mm

H811331

Colours **Special decor for H811331**



.D01

Line Pattern, grey



.D02

Lines, black

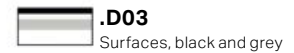

.D03

Surfaces, black and grey



Wall hanging Water Closet Bowl, rimless, washdown, cUPC approved

545 x 370 x 285 (430) mm

H820288



Wall-hung WC, 'compact', washdown, rimless

490 x 370 x 285 (430) mm

H820333



Floorstanding WC, 'rimless', washdown, without flushing rim, outlet horizontal/vertical

560 x 370 x 430 mm

H823337



UNIVERSAL

Floorstanding cistern, two-part, side water inlet (left or right) / rear inlet (left top) / inlet on the left side or at the bottom / inlet on the right side or at the bottom

400 x 140 x 980 mm

H829660 / H829661 / H829663 / H829664



WC seat and cover, removable / with lowering system

H891330 / H891331



WC seat and cover, removable / with lowering system, with round seat shape, matching to 820333

H891332 / H891333



Wall-hung bidet

545 x 370 x 290 (430) mm

H830331









Floorstanding bidet

560 x 370 x 430 mm

H832331

KARTELL BY LAUFEN

Colours **Ceramic***

-  **.000**
White
-  **.400**
White with LCC (LAUFEN Clean Coat)
-  **.757**
White matt
-  **.020**
Black glossy
-  **.716**
Black matt
-  **.758**
Graphit matt
-  **.759**
Grey matt



Vanity unit with one glass shelf, door hinge left, open shelf right for hand-washbasin tap bank left 815335 / tap bank right 815334
440 x 270 x 600 mm

H407517 / H407518



Vanity unit with two drawers, incl. organiser, for washbasin 815331

440 x 450 x 600 mm

H407508



Vanity unit with two drawers, incl. organiser, for washbasin 810332

480 x 450 x 600 mm

H407509

* not all models are available in all colors. More details on the technical pages or on our website.



Vanity unit with two drawers, incl. organiser, for washbasin shelf right 813332

1180 x 450 x 600 mm

H407648



Vanity unit, 2 drawers, incl. drawer organiser, matches washbasin 813333

1180 x 450 x 600 mm

H407649



Sideboard with 1 door and 2 flaps, washbasin left / right

1200 x 270 x 610 mm

H408291



Sideboard with 1 door and 2 flaps, washbasin left / right

1200 x 270 x 610 mm

H408292

Colours **Furniture**

-  **.640**
White matt
-  **.641**
Pebble grey
-  **.642**
Slate grey



Set of adjustable feet (2 pieces), anodized aluminium surface

175 mm

H407660





CASE

Towel holder for furniture, 270 / 320 / 400 mm

270 / 320 / 400 x 60 x 15 mm

H490950 / H490951 / H490952

Colours **Towel holder CASE**

-  **.104**
Anodised aluminium, glossy
-  **.105**
Anodised aluminium
-  **.106**
Anodised aluminium, dark brown



Bathtub, right / left corner, made of Sentec solid surface, with panel, with tap bank, with slot overflow in the side at the front, with frame
1700 x 860 mm

H223335 / H224336



Freestanding bathtub, made of Sentec solid surface, with tap bank on right-hand side, with slot overflow, with lifting system
1700 x 860 mm

H224332 / H223332



Freestanding bathtub, made of Sentec solid surface, with slot overflow and tap bank at foot end, with lifting system
1760 x 760 mm

H222332



Freestanding bathtub, made of Sentec solid surface

1715 x 815 mm

H226332

For more details see separately available technical catalogue

KARTELL BY LAUFEN



Vanity unit with two drawers, incl. organiser, for washbasin shelf left 810335

580 x 450 x 600 mm

H407568



Vanity unit with two drawers, incl. organiser, for washbasin 810333, 810338, 810339, 813332

580 x 450 x 600 mm

H407569



Vanity unit with two drawers, incl. organiser, for washbasin shelf right 810334

580 x 450 x 600 mm

H407558



Vanity unit with two drawers, incl. organiser, for washbasin shelf left 810339 / shelf right 810338

880 x 450 x 600 mm

H407608 / H407618



Side element with 1 door, left / right hinged, 1 wooden shelf

300 x 485 x 700 mm

H408271 / H408272



Tall cabinet with 1 door, left / right hinged, 4 glass shelves

400 x 270 x 1300 mm

H408281 / H408282



Tall cabinet with 1 door, left / right hinged, 4 glass shelves

350 x 335 x 1650 mm

H408287 / H408288



Set of adjustable feet (2 pieces), anodized aluminium surface

170 mm

H407620



Washbasin frame, matches washbasin 815331

395 x 440 x 790 mm

H385334



Washbasin frame, matches washbasins 810333, 810334, 810335

535 x 440 x 790 mm

H385335



Washbasin frame, matches washbasins 810338, 810339

825 x 440 x 790 mm

H385336



Bathtub, drop-in version, made of Sentec solid surface, with tap bank on left-hand / right-hand side, with slot overflow in the side at the front, with frame

1700 x 860 mm

H223331 / H224331

Colours Bathubs

.000
White



Neck cushion, black, self-adhesive, for straight bathtub contours

312 x 122 x 50 mm

H294680



Mirror 'All saints', plastic

780 x 40 x 780 mm

H386331 / H386333



Shelf 'Shellfish', wall-mounted, plastic

450 x 155 x 40 mm

H385330

For more details see separately available technical catalogue

KARTELL BY LAUFEN



Shelf for washbasin, plastic

460 x 200 x 15 mm

H385331



Shelf for bathtub, plastic

750 x 250 x 15 mm

H385332



Pendant lamp ,Rifly', 300 mm, plastic,
holder chromed

80 x 80 x 300 / 600 / 900 mm

H389333 / H389334 / H389335



Wall-mounted lamp ,Rifly', plastic,
holder chromed

80 x 85 x 300 mm

H389332



Wall tray, including storage tray ,disc',
transparent crystal

185 x 185 x 50 mm

H385333



Tumbler ,Boxy', plastic

70 x 70 x 120 mm

H382330



Soap dish ,Boxy', plastic

105 x 105 x 25 mm

H383330



Storage tray ,disc', for wall tray, toilet
paper holder and faucets ,disc' with Ø
185 mm, plastic

185 x 185 x 15 mm

H398335xx0011



Stool 'Max Beam', plastic

330 x 280 x 465 mm

H389330



Shelf 'Sound rack', plastic

750 x 260 x 530 mm

H389331



Towel holder 'Rail', 300 mm, plastic

300 / 450 / 600 x 75 x 40 mm

H381330 / H381331 / H381332



Toilet roll holder, Ø 185 mm, including storage tray 'disc', transparent crystal

185 x 185 x 80 mm

H384332

Colours Discs

	.081 Amber
	.082 Tangerine orange
	.084 Transparent crystal
	.085 Smoky grey
	.090 Opaque white
	.091 Opaque black
	.092 Emerald green
	.093 Powder pink

Colours Accessoires*

	.081 Amber
	.091 Opaque black
	.092 Emerald green
	.093 Powder pink
	.082 Tangerine orange
	.083 Blue
	.084 Transparent crystal
	.085 Smoky grey

	.086 Silver
	.087 Gold
	.089 Copper
	.090 Opaque white

* not all models are available in all colors. More details on the technical pages or on our website.

Matching mirrors and mirror cabinets can be found in the FRAME 25 / LEELO chapters. Matching shower toilets can be found in the CLEANET SHOWER TOILETS chapter.

LIVING SQUARE Design by Andreas Dimitriadis

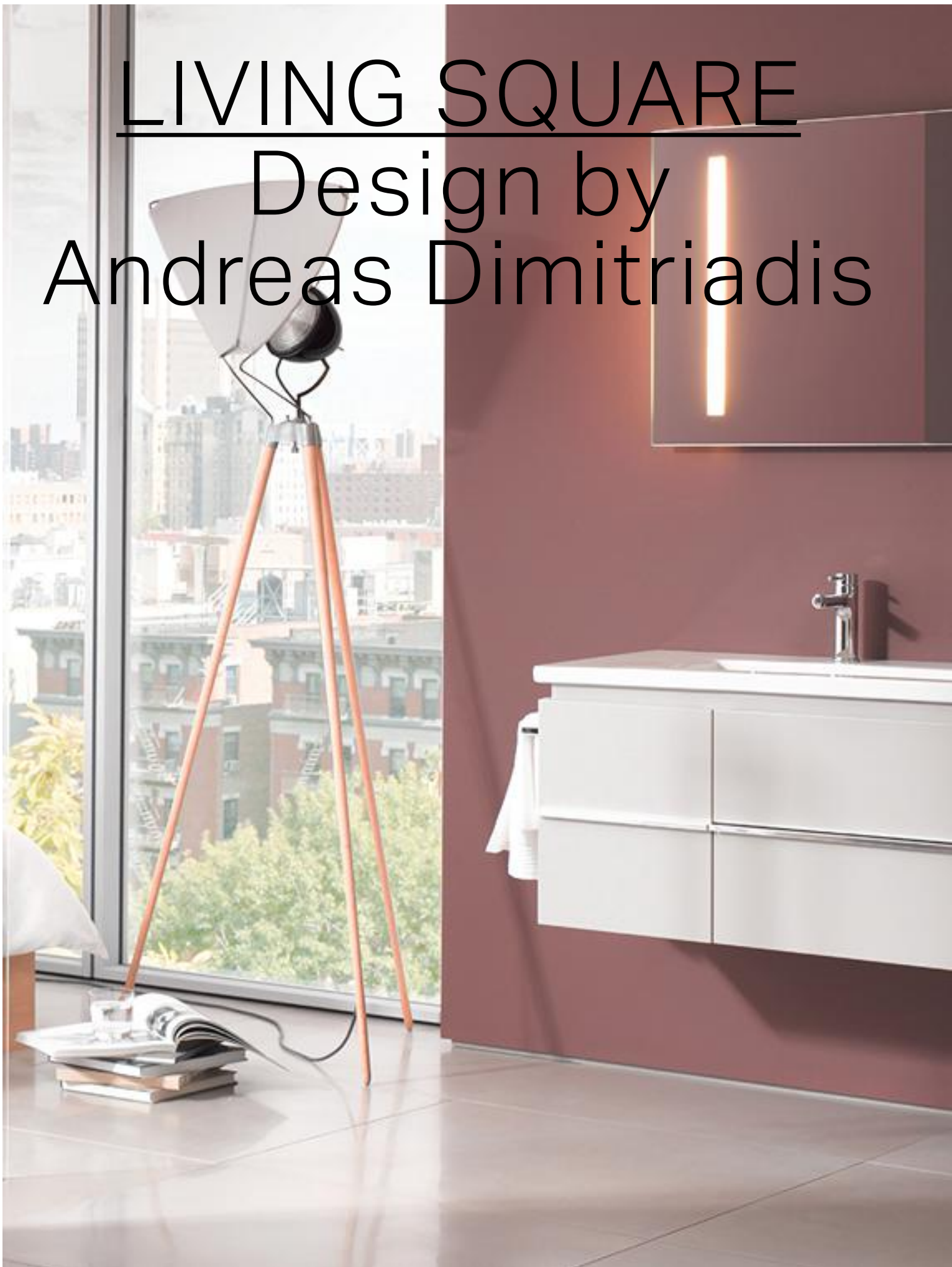

LIVING SQUARE washbasin 130; CASE vanity unit; tall cabinet; towel rail TWINPLUS basin mixer



LIVING SQUARE

Andreas Dimitriadis takes ceramic feasibility to its limits. The designer lives the DNA of each project and creates a stylised rhythm that finally unfolds in its finest form in LIVING SQUARE. Extremely flat elements with their flat surfaces and defined edges literally float in front of the wall bearing witness to an unparalleled fusion of elegance and bathroom culture. Large areas are cleverly hidden behind narrow silhouettes defining a functional wash place as the centre of the bathroom.



product
design award

2013



German
Design Award

SPECIAL
MENTION 2013



LIVING SQUARE washbasin 90 CASE vanity unit

LIVING SQUARE



LIVING SQUARE washbasin; ceramic shelf



LIVING SQUARE washbasins can be cut and trimmed to almost any size: right, left at both ends. Thanks to precise adaptation technology, they can be cut to the desired dimension to the exact millimetre in our factory according to customer specifications. This results in tailor-made solutions that can be effortlessly integrated into niches and corner situations.



LIVING SQUARE double washbasin 130 CASE vanity unit TWINPLUS basin mixer



LIVING SQUARE small washbasin 50 CASE vanity unit TWINPLUS basin mixer



LIVING SQUARE small washbasin 50 CASE vanity unit TWINPLUS basin mixer

LIVING SQUARE



Small washbasin / Drop-in washbasin

500 x 380 x 40 mm
H815434 / H815435



Washbasin / Drop-in washbasin

650 x 480 x 40 mm
H816431 / H816432



Vanity washbasin, shelf right / left

750 x 480 x 40 mm
H817438 / H817439



Washbasin / Drop-in washbasin

900 x 480 x 40 mm
H816433 / H816434

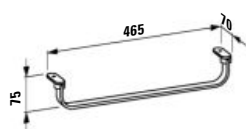

Towel holder, chromed, matches washbasin 815434 / 816431

465 x 70 x 75 mm
H381431 / H381432

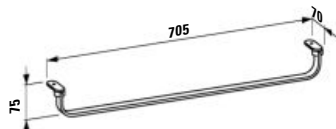

Towel holder, chromed, matches washbasins 817438, 817439 / 816433

705 x 70 x 75 mm
H381436 / H381433

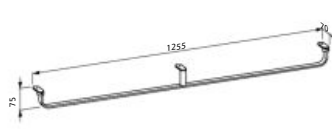

Towel holder, chromed, matches washbasins 816435, 816436

1255 x 70 x 75 mm
H381434

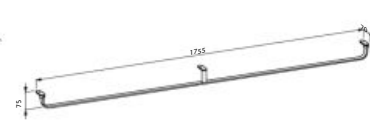

Towel holder, chromed, matches washbasin 816438

1755 x 70 x 75 mm
H381435



CASE
 Vanity unit, 1 drawer / 2 drawers, matches washbasin 816433

895 x 475 x 455 mm
H401261 / H401262



CASE
 Vanity unit, 1 drawer / 2 drawers and 2 doors, with 2 glass shelves, matches washbasins 816435, 816436

1295 x 475 x 460 mm
H401311 / H401312



CASE
 Vanity unit, 1 drawer / 2 drawers and 2 doors, with 2 glass shelves, matches washbasin 816438

1790 x 375 x 460 mm
H401261 / H401262

Colours **Ceramic Accessoires**



.000
 White



Shelf, made from sanitary ceramic, wall-hung, cutable to 650 mm

900/1200/1300/1500/1800x380x35(100)mm
H870433 / H870434 / H870435 / H870436 / H870438

For more details see separately available technical catalogue

Colours **Ceramic**



Washbasin, cuttable to 650 mm

1300 x 480 x 40 mm

H816435



Washbasin, also usable as double washbasin

1300 x 480 x 40 mm

H816436



Washbasin, cuttable to 1000 mm

1800 x 480 x 40 (120) mm

H816438



CASE

Vanity unit, 1 drawer / 2 drawers, matches washbasin 815434

490 x 375 x 455 mm

H401141 / H401142



CASE

Vanity unit, 1 drawer / 2 drawers, matches washbasin 816431

645 x 475 x 455 mm

H401211 / H401212



CASE

Vanity unit, 1 drawer / 2 drawers, matches washbasin 817438

745 x 475 x 455 mm

H401421 / H401422



CASE

Vanity unit, 1 drawer / 2 drawers, matches washbasin 817439

745 x 475 x 455 mm

H401441 / H401442

Colours **Furniture CASE**

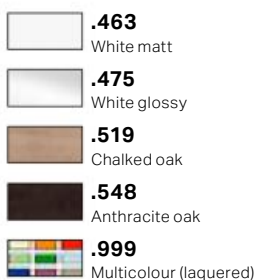

Please state colour number in the order text:



For more information on the choice of 39 colours, refer to the „Product features and benefits“ chapter.

Colours **Towel holder CASE**

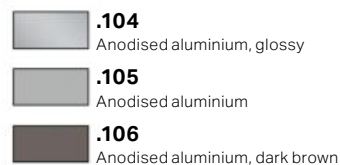

CASE

Towel holder for furniture, 270 / 320 / 400 mm

270 / 320 / 400 x 60 x 15 mm

H490950 / H490951 / H490952

Tall cabinet, trolley CASE and other furniture items can be found in the CASE chapter. Matching mirrors and mirror cabinets can be found in the FRAME 25 / LEELO. Matching shower toilets can be found in the CLEANET SHOWER TOILETS chapter.

LIVING SAPHIRKERAMIK Design by Andreas Dimitriadis



LIVING SAPHIRKERAMIK bowl washbasin round KARTELL BY LAUFEN column basin mixer



LIVING SAPHIRKERAMIK

LAUFEN opens up new perspectives. It breaks up the traditional scope for bathroom design and, since the invention of SaphirKeramik, allows us to look deep into a new era of form design.

LIVING SAPHIRKERAMIK makes full use of the accurate characteristics of this revolutionary material and sets new standards with strict lines and tightly defined edge radii, which find their perfection in finely coordinated furniture combinations.

DESIGN PLUS

PIA'13 : The 2013 Architectural Products Product Innovation Awards



 SaphirKeramik



Bowl washbasin, square

360 x 360 x 130 mm

H811433



Bowl washbasin, round

380 x 380 x 130 mm

H811435



Bowl washbasin, rectangular

600 x 340 x 110 mm

H811434

Colours **Ceramic**

 **.000**
White

 **.757**
White matt

Matching countertops can be found in the SPACE / CASE / BOUTIQUE chapters.
Matching mirrors and mirror cabinets can be found in the FRAME 25 / LEELO chapters.
Matching shower toilets can be found in the CLEANET SHOWER TOILETS chapter.

For more details see separately available technical catalogue



LIVING SAPHIRKERAMIK bowl washbasin, square 36 KARTELL BY LAUFEN twin handled concealed basin mixer BOUTIQUE drawer element

LIVING CITY Design by Phoenix Design



LIVING CITY semi-recessed washbasin 55 KARTELL BY LAUFEN basin mixer in special colour

URBAN AND MODERNISTIC

A system with corners and edges yet so flexible and easy to maintain: LIVING CITY has a clear concept and clear forms. The modular system offers washbasins with and without shelves in many widths. Reduction and individualism without peculiarity: LIVING CITY's formal language is aimed at people who love a contemporary setting and design their surroundings with sensitivity and great sense for materials.



product
design
award

2008



DESIGNPREIS
2008

NOMINIERT



LIVING CITY small bowl washbasin with tap bank 45
CASE countertop with drawer element 60

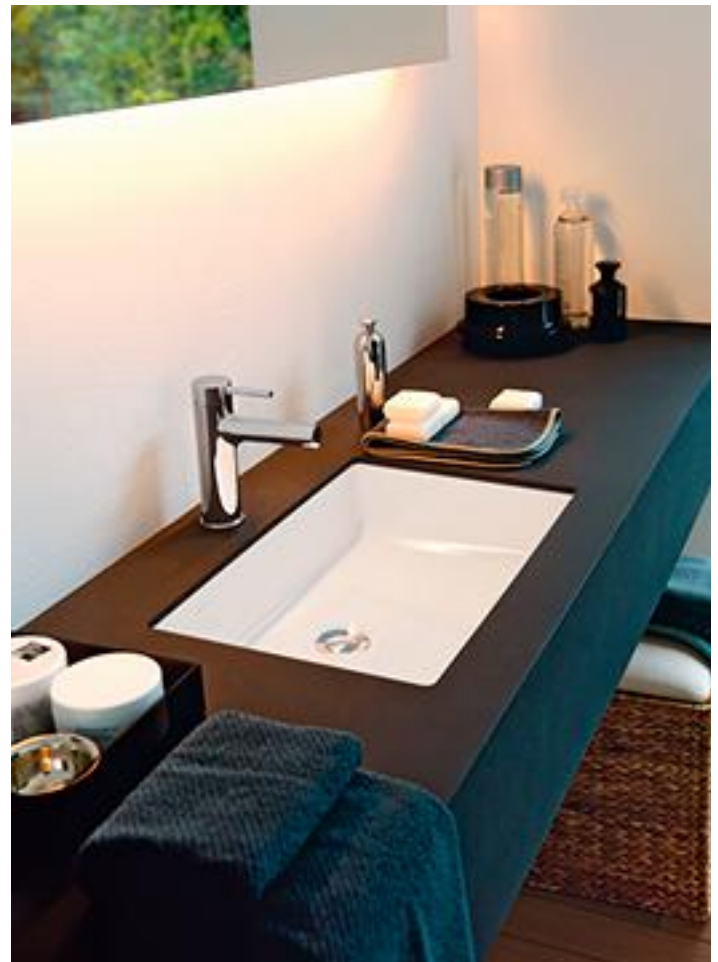

LIVING CITY under-mounted washbasin 49
TWINPLUS basin mixer

LIVING CITY



LIVING CITY washbasin 100 CASE vanity unit



LIVING CITY small washbasin 45 CASE vanity unit



LIVING CITY washbasin 100, shelf right FRAME 25 mirror



LIVING CITY washbasin 60



LIVING CITY bowl washbasin 60
CASE countertop and drawer element; towel rail

LIVING CITY



Small washbasin / Small washbasin, undersurface ground

450 x 380 x 140 mm
H815432 / H815433



Washbasin / Washbasin, undersurface ground

500 x 460 x 140 mm
H817431 / H817432



Washbasin / Washbasin, undersurface ground

600 x 460 x 140 mm
H817433 / H817434



Washbasin / Washbasin, undersurface ground

800 x 460 x 140 mm
H817436 / H817437



Under-mounted washbasin, rectangular, ground

400 x 335 x 170 mm
H812432 / H812434



Small bowl washbasin, with tap bank

450 x 380 mm
H811430



Semi-recessed washbasin, round

460 x 460 x 140 mm
H813431



Semi-recessed washbasin, rectangular

550 x 460 x 140 mm
H813432



Towel holder, chromed, matches washbasin 817431 / 817433, 818431, 818432

455 x 70 x 75 mm
H895423



Towel holder, chromed, matches washbasin 817431 / 817433, 818431, 818432

555 x 70 x 75 mm
H895424



Towel holder, chromed, matches washbasin 817436 / 818437, 818431, 818432

755 x 70 x 75 mm
H895425



Towel holder, chromed, matches washbasin 817436 / 818437, 818431, 818432

955 x 70 x 75 mm
H895426



CASE

Vanity unit, 1 drawer / 2 drawers, matches washbasins 818437, 818431, 818432

990 x 455 x 455 mm
H401281 / H401282

Colours Furniture CASE

	.463 White matt
	.475 White glossy
	.519 Chalked oak
	.548 Anthracite oak
	.999 Multicolour (laquered)

Please state colour number in the order text:

01	02	03	04	05	06	07	08
09	10	11	12	13	14	15	16
17	18	19	20	21	22	23	24
25	26	27	28	29	30	31	32
33	34	35	36	37	38	39	

For more information on the choice of 39 colours, refer to the „Product features and benefits“ chapter.



Washbasin / Washbasin, undersurface ground

1000 x 460 x 140 mm
H818437 / H818438



Washbasin, shelf left / right

1000 x 460 x 140 mm
H818431 / H818432



Under-mounted washbasin, ground

400 x 335 x 170 mm
H813439 / H813438



Under-mounted washbasin, rectangular, ground

545 x 360 x 155 mm
H812431 / H812430

Colours **Ceramic**



.000
White



Bowl washbasin, with tap bank

500 / 600 x 425 mm
H811431 / H811432



CASE

Vanity unit, 1 drawer / 2 drawers, matches washbasin 815432

440 x 375 x 455 mm
H401111 / H401112



CASE

Vanity unit, 1 drawer / 2 drawers, matches washbasin 817431

490 x 455 x 455 mm
H401131 / H401132



CASE

Vanity unit, 1 drawer / 2 drawers, matches washbasin 817433

595 x 455 x 455 mm
H401181 / H401182



CASE

Vanity unit, 1 drawer / 2 drawers, matches washbasin 817436

790 x 455 x 455 mm
H401241 / H401242

Colours **Towel holder CASE**

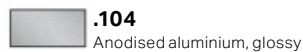

.104
Anodised aluminium, glossy



.105
Anodised aluminium

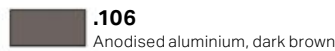

.106
Anodised aluminium, dark brown



CASE

Towel holder for furniture, 270 / 320 / 400 mm

270 / 320 / 400 x 60 x 15 mm
H490950 / H490951 / H490952

Matching tall cabinets can be found in the **CASE** chapter.
Matching mirrors and mirror cabinets can be found in the **FRAME 25 / LEELO** chapters.
Matching shower toilets can be found in the **CLEANET SHOWER TOILETS** chapter.

INO Design by Toan Nguyen



INO vanity washbasin, shelf right; vanity unit; freestanding bathtub
KARTELL BY LAUFEN wall-mounted basin mixer with tray; column bath mixer; 'Max-Beam' stool FRAME 25 mirror



INO

Toan Nguyen does not allow himself to be locked up. He loves expansiveness. Both mental and physical. This is also reflected in the new bathroom collection, which the French designer has designed for LAUFEN. Immaculate objects with simple lines and delicate yet extremely stable walls conjure up an elegant, inviting and almost weightless look. A new interpretation of classic forms which not only touches the hearts of hard-line purists.



INO washbasin 56 KARTELL BY LAUFEN basin mixer; shelf ‚Sound-rack‘; tumbler ‚Boxy‘ FRAME 25 mirror

INO



INO washbasin 90, shelf left PALOMBA COLLECTION wall-hung WC, „rimless“ KARTELL BY LAUFEN basin mixer in special colour; mirror „All Saints“
BASE FOR INO floorstanding vanity unit



INO washbasin 56 CLEANET NAVIA shower toilet, wall-hung, „rimless“ KARTELL BY LAUFEN basin mixer BASE FOR INO vanity unit
FRAME 25 mirror

INO



INO washbasin 90, shelf right and ceramic cover; vanity unit KARTELL BY LAUFEN wall-mounted basin mixer with tray



INO washbasin 90, shelf left and ceramic cover
FRAME 25 mirror



INO bowl washbasin 35 KARTELL BY LAUFEN wall-mounted basin mixer
SPACE countertop



INO drop-in washbasin 50 with ceramic cover KARTELL BY LAUFEN wall-mounted basin mixer



INO freestanding bathtub
KARTELL BY LAUFEN column bath mixer with tray



INO small washbasin 45; vanity unit
KARTELL BY LAUFEN basin mixer



Small washbasin / Small washbasin, undersurface ground

450 x 410 x 120 mm

H815301 / H816300



Washbasin / Washbasin, undersurface ground

560 x 450 x 120 mm

H810302 / H816302



Vanity washbasin, shelf left / right

900 x 450 x 120 mm

H813301 / H813302



Bowl washbasin

350 x 350 x 130 mm

H812300



INO / PALOMBA COLLECTION
Floorstanding WC, washdown, with flushing rim, outlet horizontal/vertical

360 x 560 x 430 mm

H823806



UNIVERSAL

Floorstanding cistern, two-part, side water inlet (left or right) / rear inlet (left top) / inlet on the left side or at the bottom / inlet on the right side or at the bottom

400 x 140 x 980 mm

H829660 / H829661 / H829663 / H829664



UNIVERSAL

Floorstanding cistern, side water inlet (left or right) / rear water inlet (left top) / water inlet on the left side or at the bottom / on the right side or at the bottom

400 x 140 x 980 mm

H828660 / H828661 / H828663 / H828664



INO / PALOMBA COLLECTION
Floorstanding WC close-coupled, washdown, 'rimless', outlet horizontal or vertical

700 x 360 x 460 (430) mm

H824801

Colours **Ceramic**



.000

White



.400

White with LCC (LAUFEN Clean Coat)



.757*

White matt

* not for WCs/bidets



INO / PALOMBA COLLECTION
Floorstanding bidet

560 x 360 x 430 mm

H832801

Colours **Furniture INO**



.170

White Matt



.171*

Dark walnut

* not for hanging box



Hanging box for internal drawer shelf, powder-coated matt white, matches 425401

400 x 100 x 100 mm

H495411



Bowl washbasin

500 x 350 x 130 mm

H812302



Drop-in washbasin

350 x 365 x 40 (150) mm

H817301



Drop-in washbasin

500 x 365 x 40 (150) mm

H817302



INO / PALOMBA COLLECTION
Wall-hung WC, rimless, washdown

540 x 360 x 265 (430) mm

H820802



INO / PALOMBA COLLECTION
Floorstanding WC, close-coupled, washdown, with flushing rim, outlet horizontal or vertical

700 x 360 x 460 (430) mm

H824806



INO / PALOMBA COLLECTION
Cistern, rear water inlet (centre) / side water inlet (left or right) / water inlet bottom left

345 x 165 x 435 mm

H828801 / H828802 / H828803 / H828805



INO / PALOMBA COLLECTION
WC seat and cover, removable, with lowering system

H891802



INO / PALOMBA COLLECTION
Wall-hung bidet

540 x 360 x 265 (430) mm

H830801



Vanity unit, 1 aluminium door, left / right hinged, with 2 shelves in the door, 1 shelf in the body, matches washbasin 815300

280 x 300 x 605 mm

H425301 / H425302



Vanity unit, 1 aluminium door, left / right hinged, with 2 shelves in the door, 1 shelf in the body, matches washbasin 810302

320 x 340 x 605 mm

H425351 / H425352



Vanity unit made of aluminium, 1 drawer, aluminium, matches washbasins 813301, 813302

770 x 350 x 355 mm

H425401



Tall cabinet made of aluminium, 1 door, left / right hinged, 5 shelves each in the body and door

360 x 305 x 1800 mm

H425451 / H425452



BASE

Vanity unit, 1 door, left hinged, 1 internal shelf, with handle anodized aluminum / aluminium black, matching small washbasin 815301

275 x 295 x 515 mm

H403011 / H403013



BASE

Vanity unit, 1 door, right hinged, 1 internal shelf, with handle anodized aluminum / aluminium black, matching small washbasin 815301

275 x 295 x 515 mm

H403012 / H403014



BASE

Vanity unit, 1 door, left hinged, 1 internal shelf, with handle anodized aluminum / aluminium black, matching washbasin 810302

315 x 340 x 515 mm

H403021 / H403023



BASE

Vanity unit, 1 door, right hinged, 1 internal shelf, with handle anodized aluminum / aluminium black, matching washbasin 810302

315 x 340 x 515 mm

H403022 / H403024



BASE

Vanity unit, 1 drawer, with handle anodized aluminum / aluminium black, matching vanity washbasins 813301, 813302

770 x 350 x 370 mm

H403001 / H403003



BASE

Vanity unit, 2 drawers, floorstanding, with handle anodized aluminum / aluminium black, matching vanity washbasins 813301, 813302

770 x 350 x 780 mm

H403002 / H403004



BASE

Tall cabinet, 1 door, with handle anodized aluminum / aluminum black, left hinged, 1 fixed shelf and 4 glass shelves

350 x 330 x 1650 mm

H403031 / H403033



BASE

Tall cabinet, 1 door, with handle anodized aluminum / aluminum black, right hinged, 1 fixed shelf and 4 glass shelves

350 x 330 x 1650 mm

H403032 / H403034



CASE

Towel holder for furniture, 270 / 320 mm

270 / 320 x 60 x 15 mm

H490950 / H490951







Colours **Towel holder CASE**

.104
Anodised aluminium, glossy

.105
Anodised aluminium

.106
Anodised aluminium, dark brown

Colours **Furniture BASE**

-  **.260**
White matt
-  **.261**
White glossy
-  **.262**
Light elm
-  **.263**
Dark elm
-  **.266**
Traffic Grey
-  **.999**
Multicolour (laquered)

Please state colour number in the order text:



For more information on the choice of 39 colours, refer to the „Product features and benefits“ chapter.

Colours **Bathtubs**

-  **.000**
White



Freestanding bathtub, made of Sentec solid surface

1700 x 750 mm

H231302

Freestanding bathtub, made of Sentec solid surface, with integrated head rest

1800 x 800 mm

H230302

Matching furniture can be found in the BOUTIQUE chapter.
 Matching mirrors and mirror cabinets can be found in the FRAME 25 / LEELO / BASE chapters.
 Matching shower toilets can be found in the CLEANET SHOWER TOILETS chapter.

VAL Design by Konstantin Grcic



VAL wall-hung WC 'rimless'; drop-in washbasin 55; freestanding bathtub Ø 130; wall-hung bidet; basin mixers; bidet mixer
LIS flush plate BOUTIQUE countertop to measure, 120mm thick FRAME 25 mirror



VAL

A material that offers new possibilities, a designer, who pursues new ways, a connection that creates new worlds. For a bathing experience that awakens unknown emotions. With his evolutionary designs, Konstantin Grcic architecturally stages the revolutionary SaphirKeramik from LAUFEN, thereby completing the bathroom collection VAL. Clear geometric lines, extremely narrow edges and finely textured surfaces united in harmony, open up a unique category of bathroom culture.





VAL wall-hung WC, rimless; wall-hung bidet; washbasin 53 with semi-wet area and towel holder; toilet roll holder; basin mixer; bidet mixer LEELO mirror

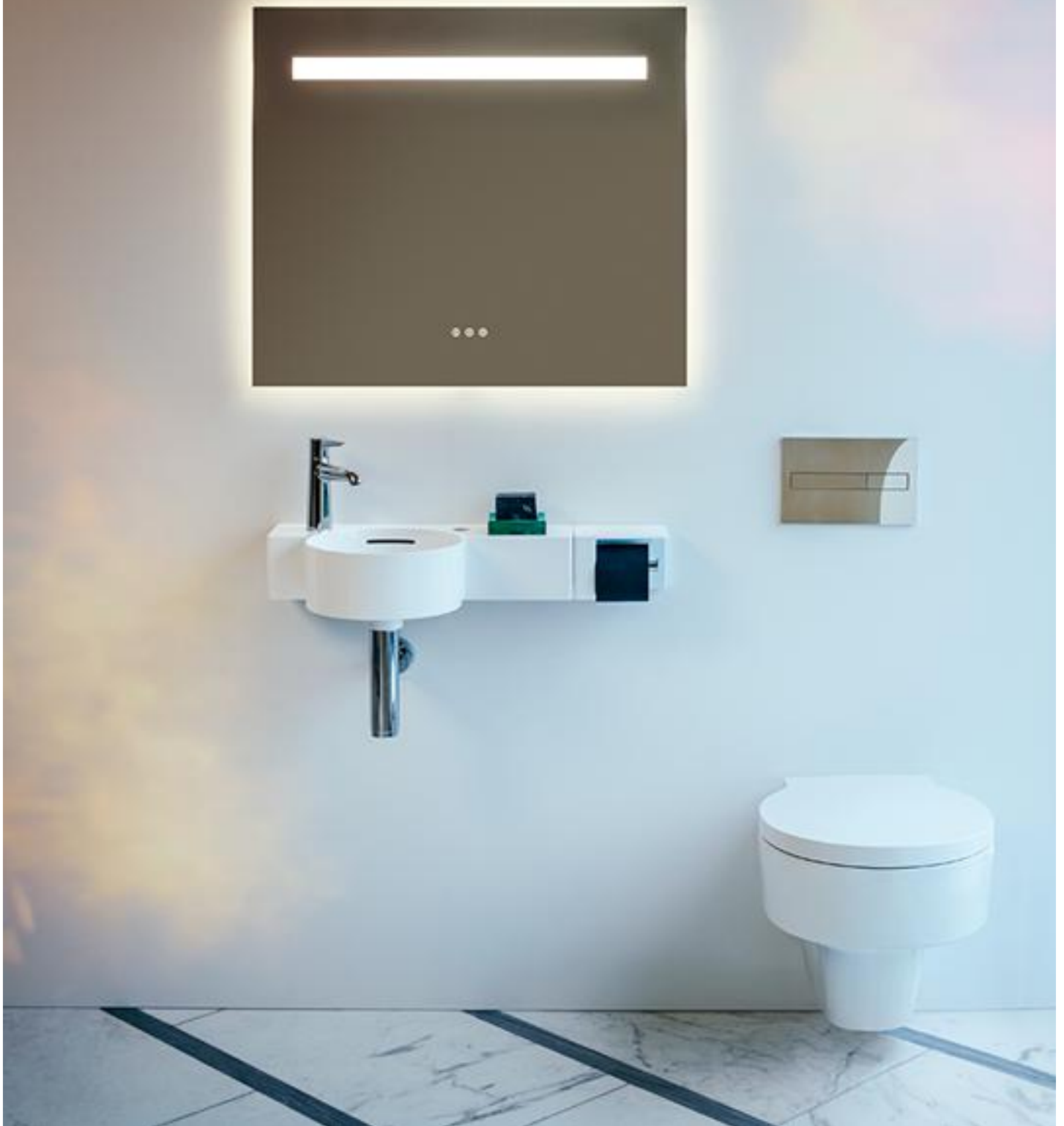

VAL small washbasin round, shelf right; wall-hung WC, rimless; toilet roll-holder; basin mixer LEELO mirror LIS flush plate KARTELL BY LAUFEN soap dish ,Boxy'



VAL washbasin 120 with semi-wet area; basin mixer BASE vanity unit LEELO mirror



VAL washbasin 53 with semi-wet area and towel holder; basin mixer



VAL washbasin 60; wall-hung WC, 'rimless'; basin mixer
BASE vanity unit, mirror cabinet and tall cabinet with small projection



VAL washbasin 60 with semi-wet area and towel holder; basin mixer



VAL washbasin 100; wall-hung WC, „rimless“; freestanding bathtub Ø 130; basin mixer; set for concealed single lever bath mixer; wall-mounted spout FRAME 25 mirror



VAL freestanding bathtub; wall-mounted single lever shower mixer with accessories



VAL washbasin 60; basin mixer



Small washbasin, with tap bank right

340 x 220 x 115 mm

H815280



VAL+BASE

Combipack, small washbasin with vanity unit ,Base' with 1 door

340 x 220 x 640 mm

H862280



Small washbasin round, shelf right, cutable to 430 mm

550 x 315 x 115 mm

H815283



Small washbasin round, shelf left, cutable to 430 mm

550 x 315 x 115 mm

H815284



Washbasin / Washbasin, undersurface ground

550 x 420 x 115 mm

H810282 / H816282



Washbasin / Washbasin, undersurface ground

600 x 420 x 115 mm

H810283 / H816283



Washbasin / Washbasin, undersurface ground

650 x 420 x 115 mm

H810284 / H816284



Washbasin / Washbasin, undersurface ground

750 x 420 x 115 mm

H810285 / H816285



Bowl washbasin, with semi-wet area (islet)

550 x 360 x 125 mm

H812282



Drop-in washbasin, with semi-wet area and tap bank

550 x 360 x 40 (145) mm

H817281



Wall-hung WC, washdown, rimless

530 x 390 x 360 (430) mm

H820281



Wall hanging Water Closet Bowl, rimless, washdown, cUPC approved

530 x 390 x 360 (430) mm

H820288



Siphonic urinal ,rimless', internal water inlet, with mounting holes for cover

305 x 365 x 560 mm

H840281



Siphonic urinal ,rimless', internal water inlet, without mounting holes for cover

305 x 365 x 560 mm

H840285



Siphonic urinal ,rimless', internal water inlet, without mounting holes for cover, with electronic control system, mains operated (230V), with integrated blue-tooth, vandalproof

305 x 365 x 560 mm

H840286 / H840284



Cover for urinal with lowering system

H894282

For more details see separately available technical catalogue



Washbasin / Washbasin „compact“, undersurface ground, with semi-wet area right
600 x 315 x 115 mm
H815285 / H817285



Washbasin / Washbasin, undersurface ground, with semi-wet area and tap bank
530 x 400 x 115 mm
H815288 / H816288



Small washbasin / Small washbasin, undersurface ground
400 x 425 x 115 mm
H811281 / H813281



Small washbasin / Small washbasin, undersurface ground
450 x 420 x 115 mm
H815281 / H816280



Washbasin / Washbasin, undersurface ground
950 x 420 x 115 mm
H810287 / H816287



Washbasin
1200 x 420 x 115 mm
H810289



Double washbasin, with semi-wet area
1200 x 420 x 115 mm
H814282



Bowl washbasin, with semi-wet area and tap bank
500 x 400 x 125 mm
H812281



Floorstanding WC, close-coupled, washdown, rimless, outlet horizontal or vertical
660 x 390 x 440 (430) mm
H824281



Cistern, rear water inlet (centre) / side water inlet (left or right) / bottom left / bottom right
365 x 150 x 395 mm
H829281 / H829282 / H829283 / H829285



WC seat and cover, removable, with lowering system
H894281



Wall-hung bidet
530 x 390 x 360 (430) mm
H830281



Ceramic urinal divider

370 x 75 x 680 mm
H847280

Colours **Ceramic***



.000
White



.400
White with LCC (LAUFEN Clean Coat)



.757
White matt

* not all models are available in all colors. More details on the technical pages or on our website.



Towel holder, matching small washbasin round, shelf left 815284 / shelf right 815283

H381280 / H381281



Towel holder, matching washbasin „compact“ 815285

H381282



Towel holder, left / right, matching double washbasin 814282

H381283 / H381284



Towel holder, matching washbasin 815288

H381285



SPACE
Vanity unit, 2 drawers, matches small washbasin 815281

435 x 410 x 520 mm

H410102



SPACE
Vanity unit, 2 drawers, matches washbasin 810282

535 x 410 x 520 mm

H410122



SPACE
Vanity unit, 2 drawers, matches washbasin 810283

585 x 410 x 520 mm

H410142







SPACE
Vanity unit, 2 drawers, matches washbasin 810284

635 x 410 x 520 mm

H410162

Colours **Furniture SPACE**

-  **.100**
White matt, with handle aluminium
-  **.101**
Light walnut, with handle aluminium
-  **.103**
Dark elm, with handle dark brown aluminium
-  **.999***
Multicolour (laquered)

Please state colour number in the order text:



For more information on the choice of 39 colours, refer to the „Product features and benefits“ chapter.

* not available for countertops and drawer units



BASE
Vanity unit, 2 drawers, incl. drawer organiser, matches washbasin 810284

635 x 390 x 530 mm

H402312



BASE
Vanity unit, 2 drawers, incl. drawer organiser, matches washbasin 810285

735 x 390 x 530 mm

H402352



BASE
Vanity unit, 2 drawers, incl. drawer organiser, matches washbasin 810287

930 x 390 x 530 mm

H402412



BASE
Vanity unit, 2 drawers, incl. drawer organiser, matches washbasin 810289

1180 x 390 x 530 mm

H402472

For more details see separately available technical catalogue

Colours **Towel holder**



SPACE
Vanity unit, 2 drawers, matches washbasin 810285

735 x 410 x 520 mm

H410182



SPACE
Vanity unit, 2 drawers, matches washbasin 810287

935 x 410 x 520 mm

H410202



SPACE
Vanity unit, 2 drawers, matches washbasin 810289, 814282

1185 x 410 x 520 mm

H410222



BASE
Vanity unit, 2 doors, matching washbasin 815285

585 x 290 x 525 mm

H402552



BASE
Vanity unit, 2 drawers, incl. drawer organiser, matches small washbasin 815281

435 x 390 x 530 mm

H402132



BASE
Vanity unit, 2 drawers, incl. drawer organiser, matches washbasin 810282

535 x 390 x 530 mm

H402192



BASE
Vanity unit, 2 drawers, incl. drawer organiser, matches washbasin 810283

585 x 390 x 530 mm

H402252



BASE
Vanity unit, 4 drawers, incl. 2 drawer organizers, matching double washbasin 814282

1180 x 390 x 530 mm

H402534

Colours **Furniture BASE**

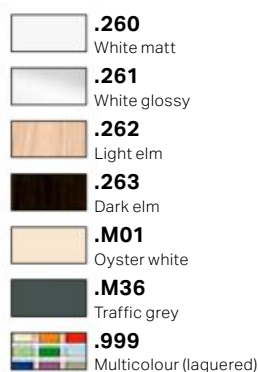



Please state colour number in the order text:



For more information on the choice of 39 colours, refer to the „Product features and benefits“ chapter.

Colours **Towel holder CASE**

-  **.104.**
Anodised aluminium, glossy
-  **.105**
Anodised aluminium
-  **.106**
Anodised aluminium, dark brown



CASE

Towel holder for furniture, 270 / 320 mm

270 / 320 x 60 x 15 mm

H490950 / H490951



Storage tray, round

325 x 325 x 60 mm

H870281



Storage tray, rectangular

360 x 280 x 60 mm

H870282



Toilet roll holder, right / left

170 x 130 x 115 mm

H872280 / H872281



Toilet brush holder incl. toilet brush

150 x 100 x 360 mm

H872282

Colours **Bathtubs**



Freestanding bathtub, made of Sentec solid surface, with integrated overflow and feet

1300 x 1300 mm

H231282

Freestanding bathtub, made of Sentec solid surface, with integrated overflow and feet

1600 x 750 mm

H230282

Backrest, light grey

400 x 90 x 625 mm

H292340

Colours **Ceramic Accessoires**



Matching tall cabinets can be found in the SPACE / BASE chapters. Matching furniture can be found in the BOUTIQUE chapter. Matching mirrors and mirror cabinets can be found in the FRAME 25 / LEELO / BASE chapters. Matching shower toilets can be found in the CLEANET SHOWER TOILETS chapter.

PALACE Design by Andreas Dimitriadis

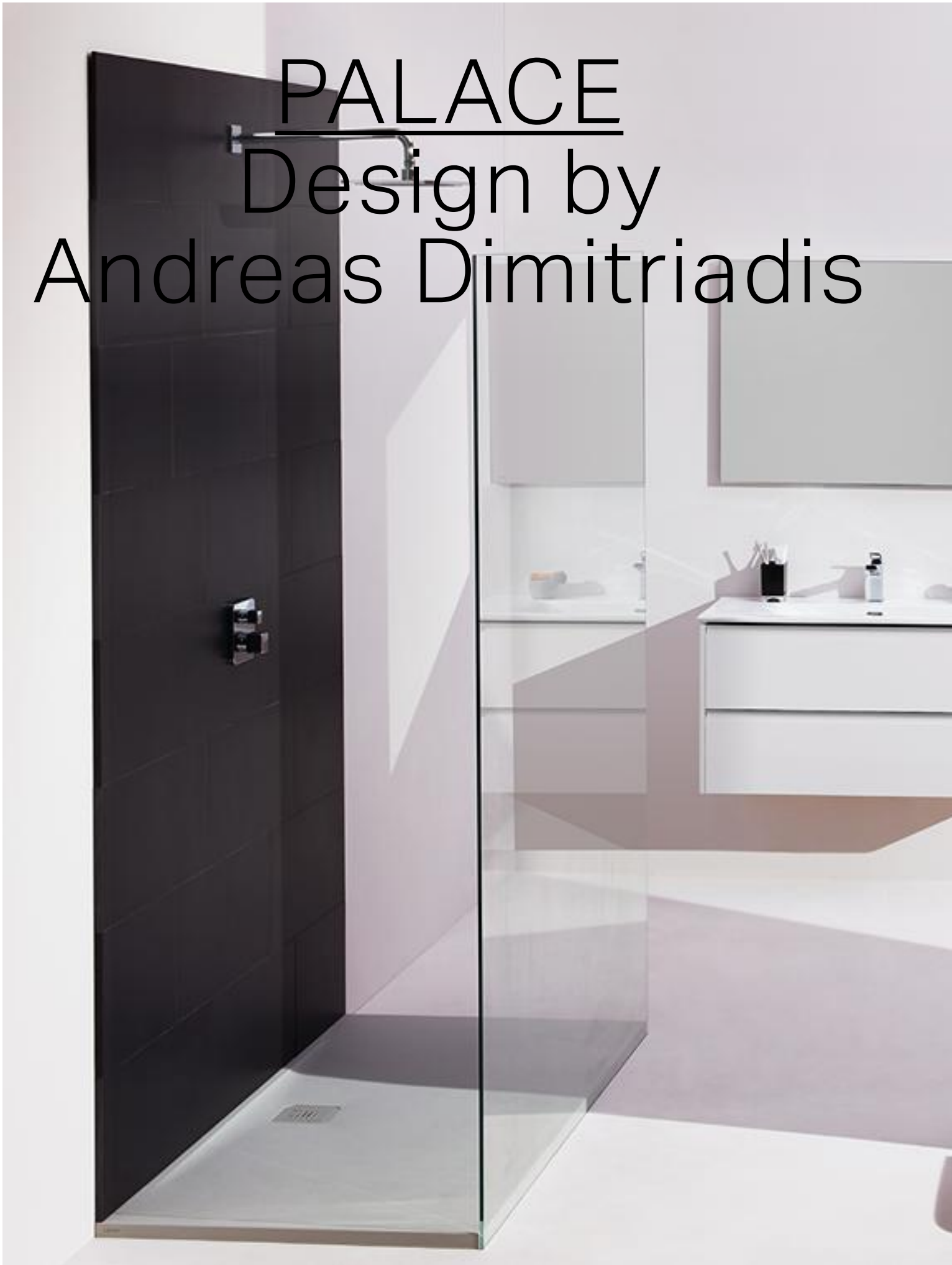

PALACE combipack 800 mm, washbasin ,slim' with vanity unit; wall-hung WC FRAME 25 mirror



PALACE

Design is not an end in itself. It is here to serve. Andreas Dimitriadis provides PALACE with humanity and authenticity. He gives each form a clear function, generates a strong emotional attraction in addition to clearly visible benefits. As a timeless classic, designed for the future, PALACE demonstrates its unique strength with cuttable washbasins. Dimitriadis' homage to ceramic as a material thus enables a tailor-made room design that previously seemed impossible.





PALACE combipack 60, washbasin ‚slim‘ with vanity unit LAUFEN PRO wall-hung WC, ‚rimless‘ FRAME 25 mirror
CITYPLUS basin mixer; thermostatic showerstation, square rain shower head

PALACE



PALACE wall-hung WC, 'rimless'; washbasin 120, shelf right; vanity unit with 2 drawers, 1 door

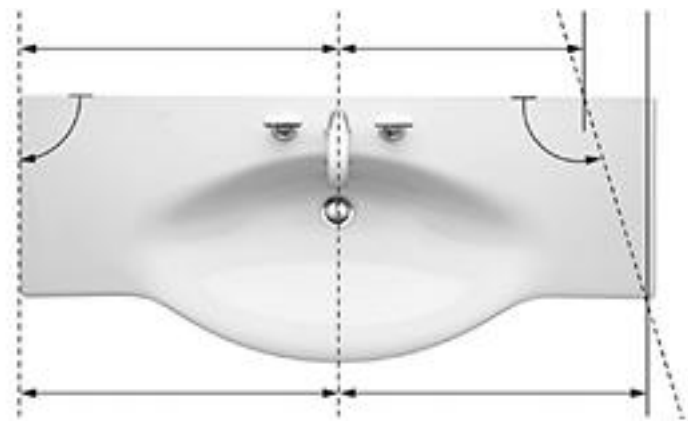

Large PALACE washbasins can be ordered made-to-measure from the factory. Thanks to the innovative production engineering, our sanitary ware can be cut and fitted into bathroom floor plans. It is possible to shorten the ceramics by cutting - even at an angle.



PALACE combipack 60, washbasin ,slim' with vanity unit



PALACE washbasin 60 CASE vanity unit 55; medium cabinet TWINPRO basin mixer

PALACE



Combipack 600 mm, washbasin ,slim' with vanity unit with 2 drawers, incl. drawer organizer, with handle anodized aluminum / aluminum black
600 x 450 x 545 mm

H860702 / H861702



Combipack 800 mm, washbasin ,slim' with vanity unit with 2 drawers, incl. drawer organizer, with handle anodized aluminum / aluminum black
800 x 450 x 545 mm

H860705 / H861705



Combipack 1000 mm, washbasin ,slim' with vanity unit with 2 drawers, incl. drawer organizer, with handle anodized aluminum / aluminum black
1000 x 450 x 545 mm

H860707 / H861707



Washbasin, shelf left / right, cuttable to 800 mm

900 x 460 x 65 (145) mm

H816701 / H816702



Vanity washbasin, cuttable to 900 mm / with chromed towel holder

1800 x 510 x 110 mm

H811708 / H812708



Double vanity washbasin, cuttable to 1350 mm / with chromed towel holder

1500 x 510 x 110 mm

H813706 / H814706



Double vanity washbasin, cuttable to 1350 mm / with chromed towel holder

1800 x 510 x 110 mm

H813708 / H814708



Wall-hung WC, washdown, rimless

560 x 360 x 345 (430) mm

H820706



UNIVERSAL

Floorstanding cistern, side water inlet (left or right) / rear water inlet (left top) / water inlet on the left side or at the bottom / on the right side or at the bottom
400 x 140 x 980 mm

H828660 / H828661 / H828663 / H828664



Floorstanding WC, close-coupled, washdown, with flushing rim, outlet horizontal or vertical

700 x 360 x 475 (430) mm

H824706



Cistern, rear water inlet (centre) / side water inlet (left or right) / bottom left / bottom right

360 x 150 x 420 mm

H828701 / H828702 / H828703 / H828705



WC seat and cover, removable, without lowering system

H891700 / H891701



BASE

Tall cabinet, 1 door, with handle anodized aluminum / aluminum black, left hinged, 1 fixed shelf and 4 glass shelves

350 x 330 x 1650 mm

H403031 / H403033



BASE

Tall cabinet, 1 door, with handle anodized aluminum / aluminum black, right hinged, 1 fixed shelf and 4 glass shelves

350 x 330 x 1650 mm

H403032 / H403034

For more details see separately available technical catalogue



Washbasin, shelf left / right, cutable to 900 mm

1200 x 460 x 65 (145) mm
H816705 / H816706

Vanity washbasin / with chromed towel holder

900 x 510 x 110 mm
H811702 / H812702

Vanity washbasin, cutable to 900 mm / with chromed towel holder

1200 x 510 x 110 mm
H811704 / H812704

Vanity washbasin, cutable to 900 mm / with chromed towel holder

1500 x 510 x 110 mm
H811706 / H812706



Wall-hung WC „compact“, washdown, with flushing rim

490 x 360 x 345 (430) mm
H820703



Wall-hung WC, washout, with flushing rim

560 x 360 x 345 (430) mm
H820702



Floorstanding WC, washdown, with flushing rim, outlet horizontal or vertical

560 x 360 x 430 mm
H823701



UNIVERSAL

Floorstanding cistern, two-part, side water inlet (left or right) / rear inlet (left top) / inlet on the left side or at the bottom / inlet on the right side or at the bottom

400 x 140 x 980 mm
H829660 / H829661 / H829663 / H829664

Colours Ceramic



Wall-hung bidet

560 x 360 x 350 (430) mm
H830701



Floorstanding bidet

560 x 360 x 440 (430) mm
H832701

Colours Furniture BASE

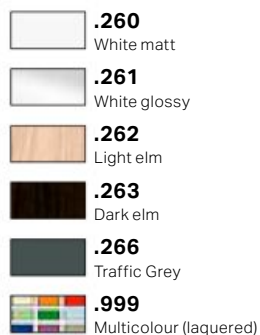

Please state colour number in the order text:

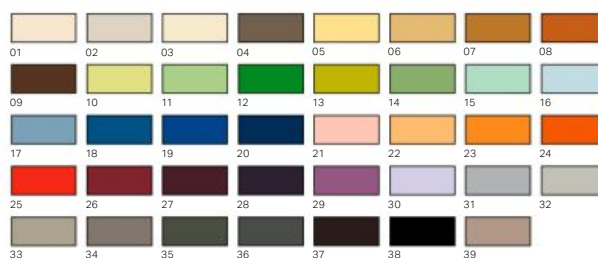

For more information on the choice of 39 colours, refer to the „Product features and benefits“ chapter.

PALACE



CASE

Vanity unit, 1 drawer / 2 drawers, 1 door, right hinged, matches washbasin 816701

840 x 375 x 450 mm

H401501 / H401502



CASE

Vanity unit, 1 drawer / 2 drawers, 1 door, left hinged, matches washbasin 816702

840 x 375 x 450 mm

H401531 / H401532



CASE

Vanity unit, 1 drawer / 2 drawers, matches washbasins 811702, 812702

895 x 375 x 460 mm

H401251 / H401252



CASE

Vanity unit, 1 drawer / 2 drawers, 1 door, right hinged, matches washbasin 816705

1140 x 375 x 450 mm

H401601 / H401602







CASE

Vanity unit, 1 drawer / 2 drawers and 2 doors, with 2 glass shelves, matches washbasins 811708, 812708, 813708, 814708

1790 x 375 x 460 mm

H401401 / H401402

Colours **Furniture CASE**

-  **.463**
White matt
-  **.475**
White glossy
-  **.519**
Chalked oak
-  **.548**
Anthracite oak
-  **.999**
Multicolour (laquered)

Please state colour number in the order text:



For more information on the choice of 39 colours, refer to the „Product features and benefits“ chapter.



CASE

Vanity unit, 1 drawer / 2 drawers, 1 door, left hinged, matches washbasin 816706

1140 x 375 x 450 mm

H401621 / H401622



CASE

Vanity unit, 1 drawer / 2 drawers and 2 doors, with 2 glass shelves, matches washbasins 811704, 812704

1195 x 375 x 460 mm

H401301 / H401302



CASE

Vanity unit, 1 drawer / 2 drawers and 2 doors, with 2 glass shelves, matches washbasins 811706, 812706

1495 x 375 x 460 mm

H401351 / H401352



CASE

Vanity unit, 1 drawer / 2 drawers and 2 doors, with 2 glass shelves, matches washbasins 813706, 814706

1495 x 375 x 460 mm

H401353 / H401354



Shelf, made from sanitary ceramic, wall-hung, cutable to 650 mm

900/1200/1300/1500/1800x380x35(100)mm

H870433 / H870434 / H870435 / H870436 / H870438



Towel holder for the left-hand side, chromed, matches washbasins 810702, 810703, 810704, 810708, 816706

400 x 25 x 75 mm

H381707 / H381708





CASE

Towel holder for furniture, 270 / 320 mm

270 / 320 x 60 x 15 mm

H490950 / H490951 / H490952

Colours Towel holder CASE

-  **.104**
Anodised aluminium, glossy
-  **.105**
Anodised aluminium
-  **.106**
Anodised aluminium, dark brown

Colours Ceramic Accessoires

-  **.000**
White

Matching tall cabinets, trolleys and other furniture items can be found in the CASE / BASE chapters.
Matching mirrors and mirror cabinets can be found in the FRAME 25 / BASE / LEELO chapters.
Matching shower toilets can be found in the CLEANET SHOWER TOILETS chapter.

LAUFEN PRO S Design by Peter Wirz



PRO S combipack washbasin 'slim' with vanity unit PRO, 80; tall cabinet PRO wall-hung WC, 'rimless' LAUFEN SOLUTIONS MARBOND shower tray
LIS flush plate CASE tall cabinet FRAME 25 mirror cabinet CITYPRO thermostatic shower station, basin mixer



LAUFEN PRO S

With lots of sensitivity Peter Wirz brought about a systematic, production-optimised evolution of the PRO concept: Thanks to its slim silhouette and clearly-defined radii, the washbasin has a light and elegant, appearance. The deep bowl means that it's also functionally appealing. The aesthetics of LAUFEN PRO S therefore definitely take the range in the direction of LAUFEN's premium design lines – while remaining affordable by all.



reddot award 2014
winner



PRO S Combipack 800 mm, washbasin ,slim' with vanity unit ,Base'

LAUFEN PRO S



PRO S washbasin 60; vanity unit
CITYPRO basin mixer



PRO S double washbasin 120; vanity unit
CASE towel rail CITYPLUS basin mixer



PRO S small washbasin 48, tap bank right; vanity unit,
1 door, shelf right, open-sided CITYPLUS basin mixer



PRO S under-mounted washbasin 55 CITYPLUS basin mixer



PRO S washbasin 60 LAUFEN SOLUTIONS Marbond shower tray
 BASE vanity unit; mirror cabinet CITYPRO basin mixer;
 wall-mounted shower mixer with accessories



PRO S washbasin 60; vanity unit; wall-hung WC CASE towel rail
 INDURA shower tray CITYPRO basin mixer CITYPLUS shower mixer



PRO S small washbasin 48, tap bank right
 BASE vanity unit



PRO S wall-hung WC, 'rimless'; wall-hung bidet CITYPRO bidet mixer

LAUFEN PRO S



PRO S double washbasin 130 PRO wall-hung WC „rimless“ BASE vanity unit; mirror cabinet LAUFEN SOLUTIONS Marbond shower tray
CITYPRO basin mixer



PRO S double washbasin 130 BASE vanity unit
CITYPRO basin mixer



PRO S combipack 120 washbasin 'slim' with vanity unit 'BASE' PRO wall-hung WC, 'rimless' BASE tall cabinet
 FRAME 25 mirror, glass shelf CITYPRO basin mixer



PRO S double washbasin 120 BASE vanity unit; tall cabinet;
 mirror cabinet CITYPRO basin mixer



PRO S combipack 80 washbasin 'slim' with vanity unit
 CITYPRO basin mixer

LAUFEN PRO S



Small washbasin, tap bank right

360 x 250 x 50 mm
H815960



Small washbasin, tap bank right / left

480 x 280 x 85 mm
H815954 / H815955



Small washbasin / Small washbasin, undersurface ground

450 x 340 x 85 mm
H815961 / H816961



Washbasin / Washbasin, undersurface ground

550 x 465 x 95 mm
H810962 / H816962



Washbasin / Washbasin, undersurface ground

1050 x 465 x 95 mm
H813966 / H816966



Washbasin

1200 x 465 x 95 mm
H814965



Double washbasin

1200 / 1300 x 465 x 95 mm
H814966 / H814968



Washbasin ,compact'/ Washbasin ,compact', undersurface ground

550 x 380 x 95 mm
H818958 / H817958



Under-mounted washbasin, with tap bank, top edge ground

490 x 360 x 170 mm
H811966



Under-mounted washbasin, top edge ground / not ground

490 x 360 x 170 mm
H811961 / H811960



Under-mounted washbasin, top edge ground / not ground

550 x 380 x 170 mm
H811968 / H811963



Under-mounted washbasin, top edge ground / not ground

600 x 400 x 170 mm
H811969 / H811965



Combipack 800 mm, washbasin ,slim' with vanity unit ,Pro' with drawer, without / with interior drawer, incl. drawer organiser
800 x 500 x 460 mm
H860963 / H860964



Combipack 1000 mm, washbasin ,slim' with vanity unit ,Pro' with 2 drawers, incl. drawer organiser
1000 x 500 x 545 mm
H861965



Combipack 1000 mm, washbasin ,slim' with vanity unit ,Pro' without / with interior drawer
1000 x 500 x 460 mm
H860965 / H860966



Combipack 1200 mm, washbasin ,slim' with vanity unit ,Pro' with 2 drawers, incl. drawer organiser
1200 x 500 x 545 mm
H861967

For more details see separately available technical catalogue

LAUFEN PRO S



Washbasin / Washbasin, undersurface ground

600 x 465 x 95 mm

H810963 / H816963



Washbasin / Washbasin, undersurface ground

650 x 465 x 95 mm

H810964 / H816964



Washbasin / Washbasin, undersurface ground

700 x 465 x 95 mm

H810967 / H816967



Washbasin / Washbasin, undersurface ground

850 x 465 x 95 mm

H813965 / H816965



Washbasin ,compact' / Washbasin ,compact', undersurface ground

600 x 380 x 95 mm

H818959 / H817959



Bowl washbasin, with tap bank

550 / 600 x 380 x 95 mm

H812952 / H812953



Bowl washbasin, rectangular

600 x 400 x 115 mm

H816952



Drop-in washbasin

560 x 440 x 20 (175) mm

H818963



Combipack 480 mm, small washbasin, asymmetric right / left with vanity unit ,Pro', incl. siphon and fastening set

480 x 280 x 690 mm

H862964 / H862965



Combipack 600 mm, washbasin ,slim' with vanity unit ,Pro' with 2 drawers, incl. drawer organiser

600 x 500 x 545 mm

H861961



Combipack 600 mm, washbasin ,slim' with vanity unit ,Pro' with drawer, without / with interior drawer, incl. drawer organiser

600 x 500 x 460 mm

H860961 / H860962



Combipack 800 mm, washbasin ,slim' with vanity unit ,Pro' with 2 drawers, incl. drawer organiser

800 x 500 x 545 mm

H861963

Colours Ceramic *

.000
White

.400
White with LCC (LAUFEN Clean Coat)

* not all models are available in all colors. More details on the technical pages or on our website.







Combipack 1200 mm, washbasin ,slim' with vanity unit ,Pro' with drawer, without / with interior drawer, incl. drawer organiser

1200 x 500 x 460 mm

H860967 / H860968

LAUFEN PRO S

Colours **Combipack with vanity unit ,Base'**





-  **.260**
White matt
-  **.261**
White glossy
-  **.262**
Light elm
-  **.263**
Dark elm
-  **.999**
Multicolour (laquered)

Please state colour number in the order text:



For more information on the choice of 39 colours, refer to the „Product features and benefits“ chapter.

Colours **Combipack with vanity unit ,Pro'**

-  **.423**
Wenge structured
-  **.463**
White matt
-  **.475**
White glossy
-  **.479**
Bright oak structured
-  **.480**
Graphite



Siphon cover for washbasin / small washbasin

200 x 285 x 325 mm

H819963



Siphon cover for washbasin / small washbasin

160 x 235 x 335 mm

H819964



Pedestal for washbasin

210 x 180 x 715 mm

H819962



Wall-hung WC ,rimless', washdown, without flushing rim

530 x 360 x 295 mm

H820962



Washbasin frame, chromed, matches washbasin 813966 / matches washbasin 813966

830 / 1030 x 445 x 745 mm

H385960 / H385961



Vanity unit, 1 door, left / right hinged, 1 glass shelf, matches washbasin 815961

415 x 320 x 580 mm

H483301 / H483302



Vanity unit, 1 door, left hinged, shelf right, open-sided, matches washbasin 815955 / right hinged, shelf left, matches washbasin 815954

470 x 275 x 605 mm

H483001



Vanity unit, 1 door, left hinged, shelf right, open-sided, matches washbasin 815955 / right hinged, shelf left, matches washbasin 815954

470 x 275 x 605 mm

H483002



Vanity unit, 1 drawer / 1 drawer and interior drawer, matches washbasin 810964

615 x 450 x 390 mm

H483421 / H483422



Vanity unit, 1 drawer / 1 drawer and interior drawer, matches washbasin 810967

665 x 450 x 390 mm

H483451 / H483452



Vanity unit, 1 drawer / 1 drawer and interior drawer, matches washbasin 813965

810 x 450 x 390 mm

H483501 / H483502



Vanity unit, 1 drawer / 1 drawer and interior drawer, matches washbasin 813966

1010 x 450 x 390 mm

H483551 / H483552

For more details see separately available technical catalogue



WC-Sitz mit Deckel, abnehmbar / mit Absenkautomatik

H891960 / H891961



Wall-hung bidet

530 x 360 x 300 mm

H830961

Colours **Ceramic**



.000

White



.400

White with LCC (LAUFEN Clean Coat)



Vanity unit, 1 drawer / 1 drawer and interior drawer, matches washbasin 818958

510 x 370 x 390 mm

H483021 / H483022



Vanity unit, 1 drawer / 1 drawer and interior drawer, incl. drawer, matches washbasin 810962

520 x 450 x 390 mm

H483351 / H483352



Vanity unit, 1 drawer / 1 drawer and interior drawer, matches washbasin 818959

550 x 370 x 390 mm

H483031 / H483032



Vanity unit, 1 drawer / 1 drawer and interior drawer, matches washbasin 810963

570 x 450 x 390 mm

H483371 / H483372



Vanity unit, 1 drawer / 1 drawer and interior drawer, matches washbasin 814965

1160 x 450 x 395 mm

H483561 / H483562



Vanity unit, 2 drawers / 2 drawers and interior drawer, incl. drawer organiser, matches washbasin 814966

1160 x 450 x 395 mm

H483563 / H483564



Vanity unit, 2 drawers / 1 drawer and interior drawer, incl. drawer organiser, matches washbasin 814968

1260 x 450 x 390 mm

H483571 / H483572



Tall cabinet, 1 door, left / right hinged, 4 glass shelves

350 x 335 x 1650 mm

H483121 / H483122

LAUFEN PRO S









Medium cabinet, 1 door, left / right hinged, 2 glass shelves

350 x 335 x 1000 mm

H483111 / H483112

Colours Furniture PRO

-  **.423**
Wenge structured
-  **.463**
White matt
-  **.475**
White glossy
-  **.479**
Bright oak structured
-  **.480**
Graphite
-  **.999**
Multicolour (laquered)

Please state colour number in the order text:



For more information on the choice of 39 colours, refer to the „Product features and benefits“ chapter.



Wall cabinet, with small projection, 1 door, left / right hinged

850 x 350 x 180 mm

H483113 / H483114



Combipack 600 mm, washbasin ‚slim‘ with vanity unit ‚Base‘ with 2 drawers, incl. drawer organiser

600 x 500 x 610 mm

H864960



Combipack 800 mm, washbasin ‚slim‘ with vanity unit ‚Base‘ with 2 drawers, incl. drawer organiser

800 x 500 x 610 mm

H864961



Combipack 1000 mm, washbasin ‚slim‘ with vanity unit ‚Base‘ with 2 drawers, incl. drawer organiser

1000 x 500 x 610 mm

H864962



BASE

Vanity unit, 2 drawers, matches washbasin 818958 / 818959

520 x 360 x 530 mm

H402152 / H402212



BASE

Vanity unit, 2 drawers, incl. drawer organiser, matches washbasin 810962 / 810963

520 x 440 x 530 mm

H402172 / H402232



BASE

Vanity unit, 2 drawers, incl. drawer organiser, matches washbasin 810964 / 810967

615 x 440 x 530 mm

H402292 / H402332







BASE

Vanity unit, 2 drawers, incl. drawer organiser, matches washbasin 813965 / 813966

810 x 440 x 530 mm

H402392 / H402452

Colours Furniture BASE

-  **.260**
White matt
-  **.261**
White glossy
-  **.262**
Light elm
-  **.263**
Dark elm
-  **.999**
Multicolour (laquered)

Please state colour number in the order text:



For more information on the choice of 39 colours, refer to the „Product features and benefits“ chapter.

For more details see separately available technical catalogue



Combipack 1200 mm, washbasin ,slim'
with vanity unit ,Base' with 2 drawers,
incl. drawer organiser
1200 x 500 x 610 mm

H864963



BASE

Vanity unit, 1 door, left / right hinged,
incl. drawer organiser, matches small
washbasin 815961
415 x 320 x 530 mm

H402111 / H402112



BASE

Vanity unit, 1 door, left hinged, incl.
drawer organiser, matches small wash-
basin 815955
470 x 265 x 530 mm

H402101



BASE

Vanity unit, 1 door, right hinged, incl.
drawer organiser, matches small wash-
basin 815954
470 x 265 x 530 mm

H402102



BASE

Vanity unit, 2 drawers, incl. drawer
organiser, matches washbasin 814965

1160 x 440 x 530 mm

H402492



BASE

Vanity unit, 4 drawers, incl. drawer
organiser, matches washbasin 814966
/ 814968

1160 x 440 x 530 mm

H402494 / H402514



CASE

Set of adjustable feet (2 pieces), height
245 / 293 / 415 / 440 mm, anodized
aluminum surface

245 / 293 / 415 / 440 mm

**H483100 / H483105 / H483101 /
H483102**



CASE

Towel holder for furniture, 270 / 320 /
400 mm

270 / 320 / 400 x 60 x 15 mm

H490950 / H490951 / H490952

Colours **Towel holder CASE**



.104

Anodised aluminium, glossy



.105

Anodised aluminium



.106

Anodised aluminium, dark brown

Matching tall cabinets and
other furniture items can be found
in the BASE chapter.
Matching mirrors and
mirror cabinets can be found in the
FRAME 25 / LEELO / BASE chapters.
Matching shower toilets can be
found in the CLEANET SHOWER
TOILETS chapter.

LAUFEN PRO A



LAUFEN PRO A washbasin 60; vanity unit LAUFEN PRO S tall cabinet LAUFEN PRO wall-hung WC; wall-hung bidet CITYPRO basin mixer; bidet mixer

LAUFEN PRO A

A Classic design integrates unobtrusively into the living space and sets timeless benchmarks. This forms the vision of the LAUFEN PRO A series, which adapts to every room situation with the most modern design and inspires with numerous variations of imaginable ceramic art. Designer Peter Wirz has designed a bathroom programme that has been intelligently optimised for the ceramic production process. Democratic design thus finds its place even in bathrooms suitable for generations.



LAUFEN PRO A



LAUFEN PRO A drop-in washbasin 56 CASE countertop; trolley; towel rail CITYPRO basin mixer



LAUFEN PRO A double washbasin 130; vanity unit CITYPRO basin mixer



LAUFEN PRO A washbasin 60; pedestal CITYPRO basin mixer



LAUFEN PRO A small washbasin 45; vanity unit CITYPRO basin mixer
LAUFEN PRO S medium cabinet



LAUFEN PRO A washbasin 55; vanity unit CITYPRO basin mixer



LAUFEN PRO A washbasin 55; semi-pedestal LAUFEN PRO S tall cabinet

LAUFEN PRO A



Small washbasin

360 x 250 x 165 mm
H816955



Small washbasin / Small washbasin, undersurface ground

450 x 340 x 115 mm
H811951 / H811952



Washbasin / Washbasin, undersurface ground

550 x 480 x 115 mm
H818951 / H817951



Washbasin / Washbasin, undersurface ground

600 x 480 x 115 mm
H818952 / H817952



Semi-recessed washbasin

560 x 440 x 115 mm
H812961



Drop-in washbasin

560 x 440 x 20 mm
H813961



Pedestal for washbasin

195 x 175 x 700 mm
H819950



Semi-pedestal for washbasin

210 x 285 x 345 mm
H819951



Washbasin frame, chromed, matches washbasin 813956 / matches washbasin 813958

830 / 1005 x 470 x 790 mm
H890956 / H890958



Vanity unit, with 1 glass shelf, matches washbasin 811951, left / right hinged

380 x 310 x 580 mm
H483011 / H483012



Vanity unit, 1 drawer / 1 drawer and interior drawer, matches washbasin 818951





470 x 450 x 390 mm
H483023 / H483024



Vanity unit, 1 drawer / 1 drawer and interior drawer, matches washbasin 818952

520 x 450 x 390 mm
H483033 / H483034

Colours Furniture

-  **.423**
Wenge structured
-  **.463**
White matt
-  **.475**
White glossy
-  **.999**
Multicolour (laquered)

Please state colour number in the order text:



For more information on the choice of 39 colours, refer to the „Product features and benefits“ chapter.



Washbasin / Washbasin, undersurface ground

650 x 480 x 115 mm

H818953 / H817953



Washbasin

850 x 480 x 115 mm

H813956



Washbasin

1050 x 480 x 115 mm

H813958



Double washbasin

1300 x 480 x 115 mm

H814967







Semi-pedestal for small washbasin

180 x 230 x 325 mm

H819952

Colours Ceramic*

	.000 White
	.400 White with LCC (LAUFEN Clean Coat)
	.018 Bahama beige
	.037 Manhattan

* not all models are available in all colors. More details on the technical pages or on our website.



Vanity unit, 1 drawer / 1 drawer and interior drawer, matches washbasin 818953

570 x 450 x 390 mm

H483041 / H483042



Vanity unit, 1 drawer / 1 drawer and interior drawer, matches washbasin 813956

770 x 450 x 390 mm

H483061 / H483062



Vanity unit, 1 drawer / 1 drawer and interior drawer, matches washbasin 813958

970 x 450 x 390 mm

H483071 / H483072



Vanity unit, 2 drawers / 2 drawers and interior drawer, incl. drawer organiser, matches washbasin 814967

1220 x 450 x 390 mm

H483081 / H483082





CASE

Towel holder for furniture, 270 / 320 / 400 mm

270 / 320 / 400 x 60 x 15 mm

H490950 / H490951 / H490952

Colours Towel holder CASE

	.104 Anodised aluminium, glossy
	.105 Anodised aluminium
	.106 Anodised aluminium, dark brown

Matching tall cabinets and other furniture items can be found in the BASE chapter.
Matching mirrors and mirror cabinets can be found in the FRAME 25 / LEELO / BASE chapters.
Matching shower toilets can be found in the CLEANET SHOWER TOILETS chapter.

LAUFEN PRO B



LAUFEN PRO B washbain 60; semi-pedestal CITYPRO basin mixer
LAUFEN PRO wall-hung WC; bath tub, drop-in version, with centre outlet, enamelled steel 3,5 mm

PRO FOR PROFESSIONAL - B LIKE BASIC

Elegance and function combined. Semi-circular washbasins in various sizes. Suitable for any type of use. The elegant shape is striking, as well as the raised rim in the Laufen PRO B series. This is a washbasin which makes a good impression everywhere.



LAUFEN PRO B under-mounted washbasin 42



LAUFEN PRO B bowl washbasin 42 CITYPRO column washbasin mixer

LAUFEN PRO B



Small washbasin

400 x 320 x 145 mm

H815951



Small washbasin

450 x 330 x 150 mm

H815952



Washbasin

550 x 440 x 160 mm

H810951



Washbasin

600 x 480 x 165 mm

H810952



Small washbasin, tap hole left or right

500 x 250 x 155 mm

H816957



Semi-recessed washbasin

560 x 440 x 165 mm

H812951



Drop-in washbasin

560 x 440 x 20 (185) mm

H813951



Under-mounted washbasin, top edge ground / not ground

420 x 420 x 120 mm

H818962 / H818961







Pedestal for washbasin

195 x 175 x 700 mm

H819950

Colours **Ceramic***

	.000 White
	.400 White with LCC (LAUFEN Clean Coat)
	.018 Bahama beige
	.037 Manhattan

* not all models are available in all colors. More details on the technical pages or on our website.







Vanity unit, 1 drawer and 1 glass shelf, with cover, matches washbasins
810951, 810952, 810953

570 x 380 x 373 mm

H483035

Colours **Furniture**

	.423 Wenge structured
	.463 White matt
	.475 White glossy
	.999 Multicolour (laquered)

Please state colour number in the order text:

							
01	02	03	04	05	06	07	08
							
09	10	11	12	13	14	15	16
							
17	18	19	20	21	22	23	24
							
25	26	27	28	29	30	31	32
							
33	34	35	36	37	38	39	

For more information on the choice of 39 colours, refer to the „Product features and benefits“ chapter.

LAUFEN PRO B



Washbasin

650 x 500 x 175 mm

H810953



Washbasin ,compact'

550 x 400 x 145 mm

H814951



Washbasin ,compact'

600 x 420 x 145 mm

H814952



Corner washbasin

440 x 380 x 170 mm

H816958



Bowl washbasin

420 x 420 x 140 mm

H812962



Bowl washbasin

520 x 390 x 150 mm

H812964



Semi-pedestal for washbasin

210 x 285 x 345 mm

H819951



Semi-pedestal for small washbasin

180 x 230 x 325 mm

H819952



CASE

Towel holder for furniture, 320 mm

320 x 60 x 15 mm

H490951



CASE

Set of adjustable feet (2 pieces), height 280 mm, anodized aluminium surface

280 mm

H483093

Colours **Towel holder CASE**



.104

Anodised aluminium, glossy



.105

Anodised aluminium



.106

Anodised aluminium, dark brown

Matching tall cabinets and other furniture items can be found in the **BASE** chapter. Matching mirrors and mirror cabinets can be found in the **FRAME 25 / LEELO / BASE** chapters. Matching shower toilets can be found in the **CLEANET SHOWER TOILETS** chapter.



LAUFEN PRO
Design by
Peter Wirz

LAUFEN PRO freestanding bathtub KARTELL BY LAUFEN column bath mixer ,disc'



DEMOCRATIC DESIGN

LAUFEN PRO's industrial design is the modern answer to the once revolutionary idea that everyone has a right to enjoy beautiful forms.



reddot award 2014
winner



consumer
favorite 2011



award 2011



LAUFEN PRO S small washbasin 48 LAUFEN PRO wall-hung WC, „rimless“ BASE vanity unit FRAME 25 mirror; glass shelf CITYPRO basin mixer LIS flush plate

LAUFEN PRO



LAUFEN PRO bathtub, drop-in version



LAUFEN PRO bathtub, drop-in version

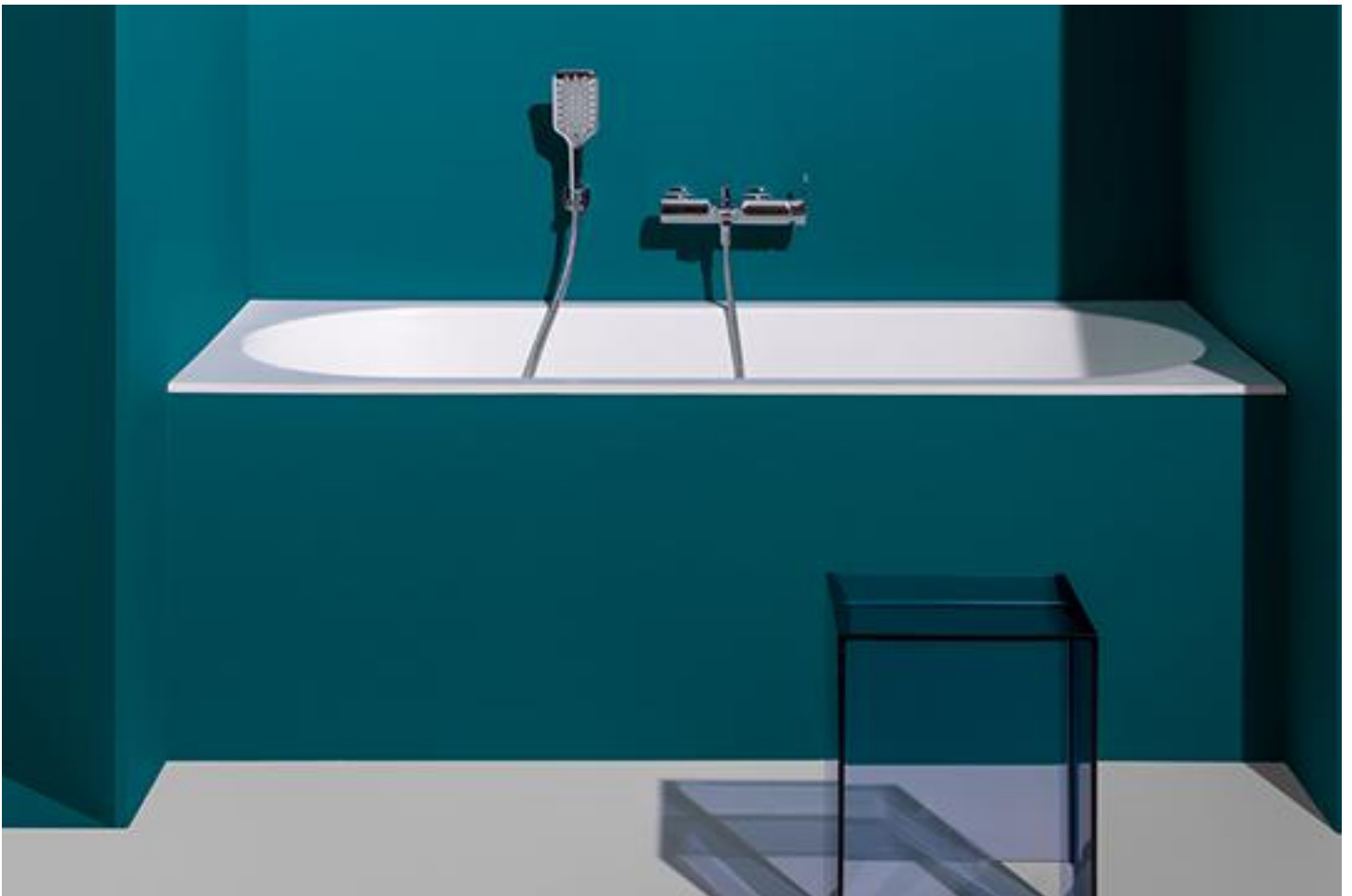

LAUFEN PRO bathtub, drop-in version



LAUFEN PRO shower tray, made of Marbond

LAUFEN PRO



LAUFEN PRO wall-hung WC UNIVERSAL ceramic toilet brush holder; ceramic toilet roll holder



LAUFEN PRO floorstanding WC, washdown, floorstanding bidet



LAUFEN PRO floorstanding WC 'comfort', washdown, sitting height 450mm, UNIVERSAL ceramic toilet brush holder; ceramic toilet roll holder



LAUFEN PRO wall-hung WC, 'rimless', with recess



LAUFEN PRO floorstanding WC, close-coupled, washdown



LAUFEN PRO wall-hung WC 'rimless'



LAUFEN PRO floorstanding WC, washdown; floorstanding bidet

LAUFEN PRO



Wall-hung WC, washdown, rimless

530 x 360 x 340 (430) mm

H820966



Wall hanging Water Closet Bowl, rimless, washdown, cUPC approved

530 x 360 x 340 (430) mm

H820968



Wall-hung WC, washdown, with recess, rimless

530 x 360 x 340 (430) mm

H820964



Wall-hung WC 'compact', washdown, rimless

490 x 360 x 340 (430) mm

H820965



Floorstanding WC, washdown, with flushing rim, outlet horizontal/vertical

530 x 360 x 430 mm

H822952



UNIVERSAL

Floorstanding cistern, two-part, side water inlet (left or right) / rear inlet (left top) / inlet on the left side or at the bottom / inlet on the right side or at the bottom

400 x 140 x 980 mm

H829660 / H829661 / H829663 / H829664



UNIVERSAL

Floorstanding cistern, side water inlet (left or right) / rear water inlet (left top) / water inlet on the left side or at the bottom / on the right side or at the bottom

400 x 140 x 980 mm

H828660 / H828661 / H828663 / H828664



Floorstanding WC, close-coupled, washdown, rimless, outlet horizontal or vertical

650 x 360 x 430 mm

H825962



Wall-hung WC 'compact', washdown, rimless

490 x 360 x 350 (430) mm

H821952



Wall-hung WC, washdown, with flushing rim (anchor screw spacing 180 / 230 mm)

560 x 360 x 350 (400) mm

H820950 / H820955



Wall-hung WC, washout, with flushing rim

560 x 360 x 350 (400) mm

H820951



Floorstanding WC, washdown, with flushing rim, outlet horizontal/vertical

580 x 360 x 400 mm

H822951



Floorstanding WC 'comfort', close-coupled, washdown, with flushing rim, outlet horizontal/vertical

700 x 360 x 480 (460) mm

H824955



Floorstanding WC, close-coupled, washdown, with flushing rim, outlet horizontal / vertical

670 x 360 x 420 (400) mm

H824956 / H824957



Floorstanding WC, close-coupled, washdown, with flushing rim, outlet horizontal/vertical

700 x 360 x 420 (400) mm

H824958



Floorstanding WC, close-coupled, washout, with flushing rim, outlet horizontal/vertical

670 x 360 x 420 (400) mm

H824959

For more details see separately available technical catalogue



Wall-hung WC, washdown, with flushing rim

530 x 360 x 340 mm

H820956



Wall-hung WC ,comfort', washdown, rimless, 5 cm raised height

560 x 360 x 450 mm

H821962



Wall-hung WC, washout, with flushing rim

530 x 360 x 350 (430) mm

H820959



Floorstanding WC, washdown, rimless, outlet horizontal or vertical

530 x 360 x 430 mm

H822956



Floorstanding WC, close-coupled, washdown, with flushing rim, outlet horizontal or vertical

650 x 360 x 440 (430) mm

H825952



Floorstanding WC close-coupled, optimized for 4.5/3L / 6/3L, washdown, rimless, outlet horizontal or vertical (CUPC approved)

700 x 360 x 430 mm

H825958



Cistern, rear water inlet (centre) / left or right / at bottom left

365 x 150 x 395 mm

H829951 / H829952 / H829953



Wall-hung WC, washdown, rimless

530 x 360 x 345 (430) mm

H820960



Floorstanding WC, washdown, with flushing rim, outlet horizontal/vertical

470 x 360 x 400 mm

H821956 / H821957



Floorstanding WC ,comfort', washdown, with flushing rim, outlet horizontal, sitting height 450 mm (without WC seat)

470 x 360 x 450 mm

H825955



Floorstanding WC ,comfort', washout, with flushing rim, outlet horizontal / vertical, sitting height 450 mm

470 x 360 x 450 mm

H825956 / H825957



Floorstanding WC, washout, with flushing rim, outlet horizontal / vertical

470 x 360 x 400 mm

H821958 / H821959



Cistern, rear water inlet (centre) / side water inlet (left or right) / side water inlet bottom left

380 x 175 x 360 mm

H826951 / H826952 / H826953



One-piece WC, siphonic action, dual flush, including seat and cover, removable, with lowering system

715 x 365 x 730 mm

H823953



Two-piece WC, siphonic action, dual flush

650 x 360 x 440 (430) mm

H825960



Cistern, water inlet bottom left for 825960

365 x 150 x 395 mm

H828963

LAUFEN PRO



Seat and cover, removable, with lowering system, hollow space fixation

H891601



WC seat and cover, removable, without / with lowering system, stainless steel hinges, hollow space fixation

H896950 / H896951



WC seat and cover, removable, without / with lowering system

H891950 / H891951



WC seat and cover, 'slim', removable, without / with lowering system, stainless steel hinges, hollow space fixation

H898965 / H898966



WC seat without cover

H892950



Wall-hung bidet

530 x 360 x 335 (430) mm

H830952



Floorstanding bidet

530 x 360 x 430 mm

H832952



Wall-hung bidet

580 x 360 x 345 (430) mm

H830951



Bathtub, rectangular, made of Marbond composite material, drop-in version

1700 x 750 / 1800 x 800 mm

H242950 / H240950



Bathtub, drop-in version, oval, made of Marbond composite material

1800 x 800 mm

H241950



Freestanding bathtub, made of Marbond composite material

1500 x 700 / 1650 x 750 mm

H243952 / H239952



Bathtub, corner version right/left, incl. feet for bathtub, made of Marbond composite material

1800 x 800 mm

H244955 / H244956



Bathtub, drop-in version / fitted version, sanitary acrylic

1700 x 750 mm

H231950 / H231951



Bathtub for right-hand corner / left-hand corner with panel, sanitary acrylic

1700 x 750 mm

H231955 / H231956



Bathtub with centre outlet, drop-in version / fitted version, sanitary acrylic

1800 x 800 mm

H232950 / H232951



Bathtub with centre outlet for right-hand corner / left-hand corner with panel, sanitary acrylic

1800 x 800 mm

H232955 / H232956

For more details see separately available technical catalogue



WC Seat and cover, 'slim', fixed stainless steel temple hinges, hollow space fixation

H898960



WC seat and cover 'universal', removable, without / with lowering system, for hollow space fixing

H893955 / H893959



WC seat and cover 'universal', removable

H893952 / H893958



WC seat and cover

H892951







Floorstanding bidet (option 304: with 1 centred tap hole, without lateral holes for water inlet)

580 x 360 x 400 mm

H832951

Colours **Ceramic***

	.000 White
	.400 White with LCC (LAUFEN Clean Coat)
	.018 Bahama beige
	.037 Manhattan

* not all models are available in all colors. More details on the technical pages or on our website.



Bathtub, drop-in version / fitted version, sanitary acrylic

1600 x 700 mm

H233950 / H233951



Bathtub for right-hand corner / left-hand corner with panel, sanitary acrylic

1600 x 700 mm

H233955 / H233956



Bathtub, drop-in version / fitted version, sanitary acrylic

1700 x 700 mm

H230950 / H230951



Bathtub for right-hand corner / left-hand corner with panel, sanitary acrylic

1700 x 700 mm

H230955 / H230956



Bathtub with centre outlet, drop-in version / fitted version, sanitary acrylic

1900 x 900 mm

H234950 / H234951



Bathtub, drop-in version, enamelled steel (3 mm) / with holes for handles pre-drilled

1500 x 700 mm

H221950 / H221953



Bathtub, drop-in version, enamelled steel (3 mm) / with holes for handles pre-drilled

1500 x 750 mm

H222950 / H222953



Bathtub, drop-in version, enamelled steel (3.5 mm) / with holes for handles pre-drilled

1600 x 700 mm

H223950 / H223953

For more details see separately available technical catalogue

LAUFEN PRO



Bathtub, drop-in version, enamelled steel (3.5 mm) / with holes for handles pre-drilled
1700 x 700 mm

H224950 / H224953



Bathtub, drop-in version, enamelled steel (3.5 mm) / with holes for handles pre-drilled
1700 x 750 mm

H225950 / H222953



Bathtub with centre outlet, drop-in version, enamelled steel (3.5 mm) / with holes for handles pre-drilled
1700 x 750 mm

H226950 / H226952



Bathtub with centre outlet, drop-in version, enamelled steel (3.5 mm) / with holes for handles pre-drilled
1800 x 800 mm

H227950 / H227952

Colours **Bathtubs**



Shower tray, made of Marbond composite material, super flat, rectangular, outlet at short side
1000 x 800 / 900 mm

H210951 / H210957



Shower tray, made of Marbond composite material, super flat, rectangular, outlet at short side
1100 x 800 / 900 mm

H212954 / H212955



Shower tray, made of Marbond composite material, super flat, rectangular, outlet at short side
1200 x 700 / 800 / 900 / 1000 mm

H212951 / H210952 / H210958 / H211953



Shower tray, made of Marbond composite material, super flat, square, outlet at side
1500 x 1500 mm

H213953



Shower tray, made of Marbond composite material, super flat, rectangular, outlet at short side
1600 x 700 / 750 / 800 / 900 mm

H213954 / H213955 / H213958 / H213959



Shower tray, made of Marbond composite material, super flat, rectangular, outlet at short side
1700 x 750 / 800 mm

H214951 / H214953



Shower tray, made of Marbond composite material, super flat, rectangular, outlet at short side
1800 x 750 / 800 mm

H214959 / H211959

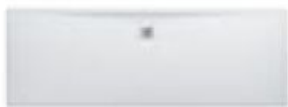

Shower tray, made of Marbond composite material, super flat, rectangular, outlet at long side
1800 x 700 / 750 mm

H214956 / H214958



Shower tray, made of Marbond composite material, super flat, rectangular, outlet at long side
1800 x 800 / 900 / 1000 mm

H210955 / H211951 / H211956

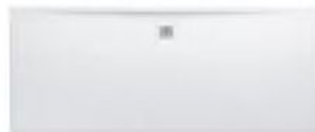

Shower tray, made of Marbond composite material, super flat, rectangular, outlet at long side
2000 x 900 / 1000 mm

H215953 / H211957



Shower tray, made of Marbond composite material, super flat, made-to-measure

750 - 2000 x 700 - 1000 mm

H212950

For more details see separately available technical catalogue



Neck cushion, black, self-adhesive, for curved bathtub contours

355 x 190 x 30 mm

H294103



Shower tray, made of Marbond composite material, super flat, square, outlet at side

800 x 800 / 900 x 900 mm

H210950 / H210956



Shower tray, made of Marbond composite material, super flat, square, outlet at side

1000 x 1000 / 1200 x 1200 mm

H211952 / H211958



Shower tray, made of Marbond composite material, super flat, rectangular, outlet at long side

900 x 800 mm

H214950



Shower tray, made of Marbond composite material, super flat, rectangular, outlet at short side

1300 x 700 mm

H212952



Shower tray, made of Marbond composite material, super flat, rectangular, outlet at short side

1400 x 700 / 800 / 900 mm

H212953 / H212956 / H212957



Shower tray, made of Marbond composite material, super flat, square, outlet at side

1400 x 1400 mm

H212958



Shower tray, made of Marbond composite material, super flat, rectangular, outlet at short side

1500 x 700 / 800 / 900 mm

H212959 / H213951 / H213952

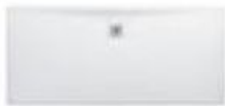

Shower tray, made of Marbond composite material, super flat, rectangular, outlet at long side

1400 x 700 / 800 mm

H215954 / H210953



Shower tray, made of Marbond composite material, super flat, rectangular, outlet at long side

1400 x 900 / 1000 mm

H210959 / H211954



Shower tray, made of Marbond composite material, super flat, rectangular, outlet at long side

1600 x 700 / 750 mm

H213956 / H213957



Shower tray, made of Marbond composite material, super flat, rectangular, outlet at long side

1600 x 800 / 900 / 1000 mm

H210954 / H211950 / H211955

Colours Shower trays

 **.000**
White matt, structured

 **.077**
Light grey matt, structured

 **.078**
Anthracite matt, structured

BOWL WASHBASINS

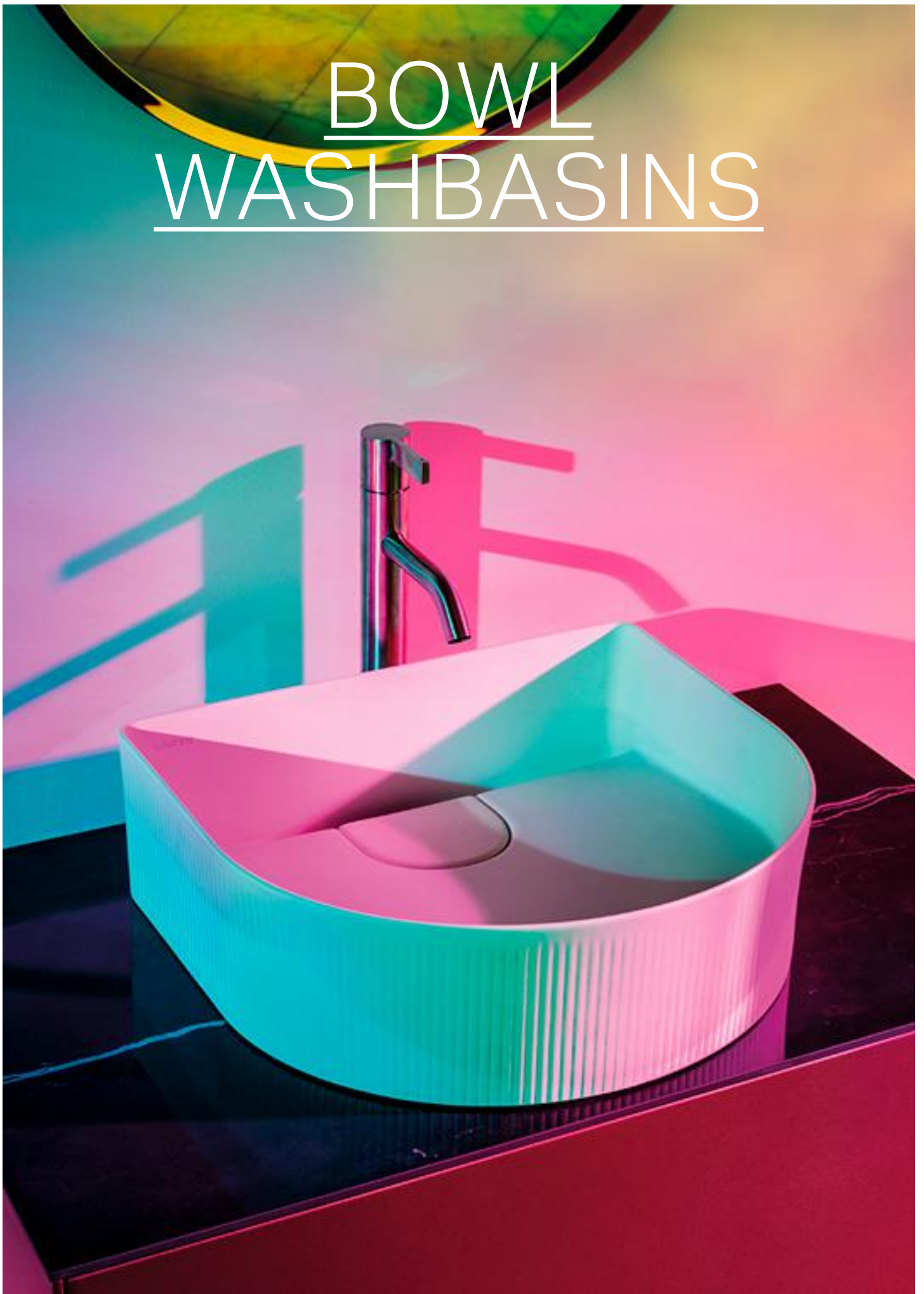

SONAR bowl washbasin 41 with surface structure, incl. ceramic waste cover KARTELL BY LAUFEN basin mixer

CUTTING A STRIKING FIGURE

The original washbasin. What was once effectively a portable water container now provides elegant highlights in the bathroom. The bowl washbasin embodies a timeless chapter in bathroom history.



THE NEW CLASSIC bowl washbasin 55, ceramic mirror with LED ambiente light; column single lever basin mixer

BOWL WASHBASINS



SONAR

Bowl washbasin without / with surface structure, incl. ceramic waste cover

340 x 340 x 130 mm

H812340 / H812341



SONAR

Bowl washbasin without / with surface structure, incl. ceramic waste cover

410 x 365 x 130 mm

H812342 / H812343



SONAR

Double bowl washbasin without / with surface structure, incl. ceramic waste cover

1000 x 370 x 130 mm

H812348 / H812349



ILBAGNOALESSI ONE

High bowl washbasin, without overflow, incl. ceramic waste cover

450 x 450 x 400 mm

H811973



PALOMBA COLLECTION

Bowl washbasin, with semi-wet area and tap bank

600 x 400 x 130 mm

H816803



PALOMBA COLLECTION

Bowl washbasin

900 x 420 x 160 mm

H816801



KARTELL BY LAUFEN

Bowl washbasin

420 x 420 x 120 mm

H812331



KARTELL BY LAUFEN

Bowl washbasin with tap bank, with concealed outlet

750 x 350 x 120 mm

H812332



LIVING CITY

Small bowl washbasin, with tap bank

450 x 380 x 140 mm

H811430



LIVING CITY

Bowl washbasin, with tap bank

500 / 600 x 425 x 140 mm

H811431 / H811432



INO

Bowl washbasin

350 x 350 x 130 mm

H812300



INO

Bowl washbasin

500 x 350 x 130 mm

H812302



LAUFEN PRO
Bowl washbasin

420 x 420 x 140 mm

H812962



LAUFEN PRO
Bowl washbasin

520 x 390 x 150 mm

H812964



SAVOY
Bowl washbasin

420 x 420 x 120 mm

H812942

For more details see separately available technical catalogue

BOWL WASHBASINS



ILBAGNOALESSI ONE
Bowl washbasin with tap bank, with concealed overflow, incl. ceramic waste cover
520 x 520 x 175 mm
H818971



ILBAGNOALESSI ONE
Bowl washbasin, with tap bank, flat, with concealed overflow, incl. ceramic waste cover
750 x 520 x 90 mm
H818972



ILBAGNOALESSI ONE
Bowl washbasin, shelf positionable right or left, incl. ceramic waste cover
800 x 420 x 145 mm
H818973



PALOMBA COLLECTION
Bowl washbasin
520 x 380 x 130 mm
H816802



THE NEW CLASSIC
Bowl washbasin, oval
550 x 380 x 145 mm
H812852 / H812853



LIVING SAPHIRKERAMIK
Bowl washbasin, square
360 x 360 x 130 mm
H811433



LIVING SAPHIRKERAMIK
Bowl washbasin, rectangular
600 x 340 x 110 mm
H811434



LIVING SAPHIRKERAMIK
Bowl washbasin, round
380 x 380 x 130 mm
H811435



VAL
Bowl washbasin, with semi-wet area and tap bank
500 x 400 x 125 mm
H812281



VAL
Bowl washbasin, with semi-wet area (islet)
550 x 360 x 125 mm
H812282



LAUFEN PRO S
Bowl washbasin, with tap bank
550 / 600 x 380 x 95 mm
H812952 / H812953



LAUFEN PRO S
Bowl washbasin, rectangular
600 x 400 x 115 mm
H816952

Matching countertops can be found in the SPACE / CASE / BOUTIQUE chapters.
Matching mirrors and mirror cabinets can be found in the FRAME 25 / LEELO / BASE chapters.

WASHBASINS, UNDERSURFACE GROUND



THE NEW CLASSIC small washbasin 50, undersurface ground; ceramic mirror with LED ambiente light; ceramic soap dish; ceramic tooth brush holder; column single lever basin mixer

WASHBASINS WITH POLISH

The ground undersurface of the countertop washbasins sits firmly on top of the furniture. When ceramics are combined with stone, wood or metal bases, this opens up a wide range of interior design possibilities.



KARTELL BY LAUFEN washbasin 50, undersurface ground; basin mixer; tray for washbasin

WASHBASINS UNDERSURFACE GROUND



SONAR
Small washbasin, undersurface ground,
incl. ceramic waste cover

SONAR
Washbasin, undersurface ground

SONAR
Washbasin, undersurface ground

KARTELL BY LAUFEN
Small washbasin with concealed outlet,
undersurface ground

410 x 420 x 140 mm

H816341

600 x 420 x 140 mm

H816342

1000 x 420 x 140 mm

H816347

460 x 460 x 120 mm

H818331



LIVING CITY
Small washbasin, undersurface ground

LIVING CITY
Washbasin, undersurface ground

LIVING CITY
Washbasin, undersurface ground

INO
Small washbasin, undersurface ground

450 x 380 x 140 mm

H815433

500 / 600 x 460 x 140 mm

H817432 / H817434

800 / 1000 x 460 x 140 mm

H817437 / H818438

450 x 410 x 120 mm

H816300



VAL
Small washbasin, undersurface ground

VAL
Washbasin, undersurface ground

VAL
Washbasin, undersurface ground

LAUFEN PRO S
Small washbasin, undersurface ground

450 x 420 x 115 mm

H816280

550 / 600 / 650 x 420 x 115 mm

H816282 / H816283 / H816284

750 / 950 x 420 x 115 mm

H816285 / H816287

450 x 340 x 85 mm

H816961



LAUFEN PRO S
Washbasin, undersurface ground

LAUFEN PRO A
Small washbasin, undersurface ground

LAUFEN PRO A
Washbasin, undersurface ground

1050 x 465 x 95 mm

H816966

450 x 340 x 115 mm

H811952

550 / 600 / 650 x 480 x 115 mm

H817951 / H817952 / H817953

For more details see separately available technical catalogue

WASHBASINS UNDERSURFACE GROUND



KARTELL BY LAUFEN
Washbasin, undersurface ground

500 / 600 x 460 x 120 mm
H816332 / H816333



KARTELL BY LAUFEN
Washbasin, shelf right / shelf left, with
concealed outlet, undersurface ground

600 x 460 x 120 mm
H818334 / H818335



KARTELL BY LAUFEN
Washbasin, shelf right / shelf left, with
concealed outlet, undersurface ground

900 x 460 x 120 mm
H818338 / H818339



THE NEW CLASSIC
Small washbasin, undersurface ground

500 x 450 x 135 mm
H816852



INO
Washbasin, undersurface ground

560 x 450 x 120 mm
H816302



VAL
Washbasin ,compact', undersurface
ground, with semi-wet area right

600 x 315 x 115 mm
H817285



VAL
Washbasin, undersurface ground, with
semi-wet area and tap bank

530 x 400 x 115 mm
H816288



VAL
Small washbasin, undersurface ground

400 x 425 x 115 mm
H813281



LAUFEN PRO S
Washbasin, undersurface ground

550 / 600 / 650 x 465 x 95 mm
H816962 / H816963 / H816964



LAUFEN PRO S
Washbasin ,compact', undersurface
ground

550 / 600 x 380 x 95 mm
H817958 / H817959



LAUFEN PRO S
Washbasin, undersurface ground

700 x 465 x 95 mm
H816967



LAUFEN PRO S
Washbasin, undersurface ground

850 x 465 x 95 mm
H816965

Matching other furnitures can be
found in the SPACE / CASE / BOU-
TIQUE chapters.
Matching mirrors and mirror cabi-
nets can be found in the FRAME 25 /
LEELO / BASE chapters.

SEMI-RECESSED WASHBASINS



LIVING CITY semi-recessed washbasin 40 KARTELL BY LAUFEN basin mixer

WASHBASINS IN SMALL SPACES

The recessed washbasins project out from a narrow, space-saving countertop. In hotel bathrooms, and wherever space is limited, semi-recessed washbasins are an elegant solution that allow greater freedom of movement.



LIVING CITY
Semi-recessed washbasin, round

460 x 460 x 140 mm
H813431



LIVING CITY
Semi-recessed washbasin, rectangular

550 x 460 x 140 mm
H813432



LAUFEN PRO A
Semi-recessed washbasin

560 x 440 x 115 mm
H812961



LAUFEN PRO B
Semi-recessed washbasin

560 x 440 x 165 mm
H812951

For more details see separately available technical catalogue

DROP-IN WASHBASINS



VAL drop-in washbasin BOUTIQUE made-to-measure countertop KARTELL BY LAUFEN basin mixer

INDIVIDUAL SOLUTIONS

The ceramic basin is lowered from above into the cut-out in the washbasin countertop. Bathrooms can be designed to individual requirements using a combination of countertops and basins with a wide variety of forms and colours.

Matching countertops can be found in the SPACE / CASE / BOUTIQUE chapters.
Matching mirrors and mirror cabinets can be found in the FRAME 25 / LEELO / BASE chapters.



INO
Drop-in washbasin

350 x 365 x 40 (150) mm

H817301



INO
Drop-in washbasin

500 x 365 x 40 (150) mm

H817302



VAL
Drop-in washbasin, with semi-wet area and tap bank

550 x 360 x 40 (145) mm

H817281



LIVING SQUARE
Drop-in washbasin, wall-mounted, undersurface ground

500 x 380 x 40 (120) mm

H815435



LIVING SQUARE
Drop-in washbasin, wall-mounted, undersurface ground

650 x 480 x 40 (120) mm

H816432



LIVING SQUARE
Drop-in washbasin, wall-mounted, undersurface ground

900 x 480 x 40 (120) mm

H816434



LAUFEN PRO S
Drop-in washbasin

560 x 440 x 20 (175) mm

H818963



LAUFEN PRO A
Drop-in washbasin

560 x 440 x 20 mm

H813961



LAUFEN PRO B
Drop-in washbasin

560 x 440 x 20 (185) mm

H813951



FIORA
Drop-in washbasin, with tap bank

490 x 490 x 15 mm

H811772



INDOVA
Drop-in washbasin, with tap bank

570 x 450 x 12 mm

H811391



INDOVA
Drop-in washbasin, with tap bank

610 x 480 x 12 mm

H811392

For more details see separately available technical catalogue

UNDER-MOUNTED WASHBASINS



LIVING CITY under-mounted washbasin 60 TWINPLUS basin mixer

SEAMLESS INTEGRATION

This allows the washbasin to be seamlessly integrated into your bathroom. The ceramic bowl is installed in the washbasin countertop from below. The flush fit between the bowls and natural stone, plastic or wooden countertop makes the ensemble easy to clean.



LIVING CITY

Under-mounted washbasin, rectangular, top edge ground / not ground

545 x 360 x 155 mm

H812431 / H812430



LIVING CITY

Under-mounted washbasin, rectangular, top edge ground / not ground

400 x 335 x 170 mm

H812432 / H812434



LIVING CITY

Under-mounted washbasin, top edge ground / not ground

400 x 335 x 170 mm

H813439 / H813438



LAUFEN PRO S

Under-mounted washbasin, with tap bank, top edge ground

490 x 360 x 170 mm

H811966



LAUFEN PRO S

Under-mounted washbasin, top edge ground / not ground

490 x 360 x 170 mm

H811961 / H811960



LAUFEN PRO S

Under-mounted washbasin, top edge ground / not ground

550 x 380 x 170 mm

H811968 / H811963



LAUFEN PRO S

Under-mounted washbasin, top edge ground / not ground

600 x 400 x 170 mm

H811969 / H811965



LAUFEN PRO

Under-mounted washbasin, top edge ground / not ground

420 x 420 x 120 mm

H818962 / H818961



BIROVA

Under-mounted washbasin, top edge ground

490 x 355 x 200 mm

H811191



BIJOU

Under-mounted washbasin, with tap bank, top edge ground

415 x 365 x 205 mm

H811220



BIJOU

Under-mounted washbasin, with tap bank, top edge ground

480 x 400 x 215 mm

H811230



SAVOY

Under-mounted washbasin, top edge ground

500 x 350 x 205 mm

H813192

For more details see separately available technical catalogue

CLEANET SHOWER TOILETS Design by Peter Wirz



CLEANET RIVA shower toilet ,rimless'



KARTELL BY LAUFEN washbasin 60 with vanity unit, single lever basin mixer, mirror „All Saints”; shelf „Sound-rack”; towel holder „Rail”

CLEANET SHOWER TOILETS

Shower toilets have been number one in matters of hygiene for a long time and are now standard in more and more bathrooms. The comfort of intimate washing with pure water has proven itself through constant technological progress. Their aesthetic qualities have become aligned with the formal expression of modern bathroom design and therefore embody the highest demands in terms of design: form and functionality for a better quality of life in the bathroom.



PERFECTLY COMFORTABLE

The Cleanet shower toilets blend seamlessly into any bathroom interior with their timeless ceramic body. This means increased design quality, thanks to the familiar aesthetics, as well as improved quality of living, thanks to intimate washing with pure water.

EASY TO USE

The great feeling of freshness and cleanliness, always within reach: the rotary button on the Cleanet shower toilet enables easy and intuitive use of the many shower functions. Turn and press – hygiene can be that easy. Additional functions and settings can be accessed via remote control or app.



THOROUGHLY CLEAN

The Cleanet shower toilets offer all-round optimum hygiene and cleanliness. The multi-level hygiene concept ranges from the basic shower functions, to self-cleaning after every use, all the way through to simple maintenance cleaning and automatic descaling.

COMPARISON TABLE

	RIVA	NAVIA
HYGIENE		
Enclosed ceramic body	✓	✓
Ceramic surface refinement LCC	✓	✓
Rimless shape of pan	✓	✓
Shower head cleaning	✓	✓
Shower head lowered into ceramic body	✓	✓
Exchangeable shower head	✓	✓
Removable seat and cover	✓	✓
Automated descaling function	✓	✓
Thermal cleaning with water at 70 °C	✓	
Device flushing via APP	✓	✓
OPERATION		
Intuitive operation using rotary button	✓	✓
Touchscreen remote control	✓	
Operation via APP	✓	✓
User detection	✓	
FUNCTIONS		
Rear shower	✓	✓
Lady shower	✓	
Power mode	✓	
Oscillating mode	✓	✓
Pulsating mode	✓	
Programmable shower duration	✓	
Jet intensity, levels	7	7
Shower jet position, levels	7	7
Shower temperature, levels	7	7 (via APP)
Programmable user profiles	4	1 (via APP)
Automatic air purifier	✓	
Night light	✓	
Indicator light	✓	✓
Economy mode	✓	✓ (via APP)
Seat and cover with lowering system	✓	✓
Integrated sound protection	✓	✓
PRODUCT DIMENSIONS	600 × 395 mm	580 × 370 mm

Colours **Ceramic**

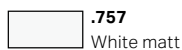
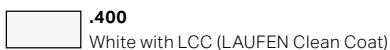

RIVA

Shower Toilet, wall-hung, rimless, washdown, incl. seat and cover, removable, with lowering system incl. remote control with touch screen
600 x 395 x 405 (430) mm

H820691



NAVIA

Shower Toilet, wall-hung, rimless, washdown, incl. seat and cover, removable, with lowering system

580 x 370 x 380 (430) mm

H820601



Adapter plate for shower toilet installation with connections above 9 cm outside of centre

450 x 450 x 25 mm

H894690



LIS

Installation system LIS CW2 with cistern for wall-hung WC and shower toilet, dual flush 6/3L resp. 4.5/3L

500 x 140-195 x 1120-1320 mm

H894661 / H894666

For more details see separately available technical catalogue

CLEANET RIVA

Pure theory takes shape - in the form of a flawlessly designed unit featuring a technically advanced interior. The visionary concept is apparent in the strikingly sensitive design of this incomparable shower toilet, which boasts an intuitive stainless steel control system. Thanks to its patented technology, this design takes the holistic approach - incorporating design, comfort and hygiene - to an entirely new level, and has been rewarded with the most prestigious design awards.



DESIGN **PLUS**



reddot award 2016
winner



CLEANET RIVA control unit with rotary button with separate button for lady shower

CLEANET RIVA



SWISS MADE
QUALITY
SWISS MADE

CLEANET RIVA shower toilet, 'rimless' LIS installation system for wall-hung WCs + flush plate VAL washbasin 75 KARTELL BY LAUFEN basin mixer



Minimalist compact design similar to a standard toilet



The exchangeable shower head is lowered into the ceramic body with a cover ring



Enclosed ceramic body with hidden water and electricity supply



Automatic air purifier with active carbon filter

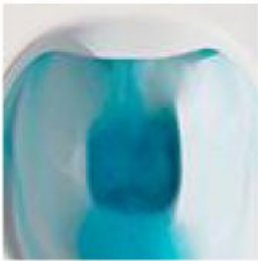

Hygienic and easy to maintain thanks to its shape without flushing rim and the LCC-finished ceramic surface



LED night light with signal function



Intuitive operation using the rotary button or by remote control



Various user profiles, which can be programmed via remote control



Powerful yet gentle shower jet with optimal distance and angle



Integrated self-cleaning functions with thermal cleaning and automated descaling



Gentle lady shower with separate button



Removable seat and cover made of Duroplast with lowering system



Thorough shower head cleaning before and after each use

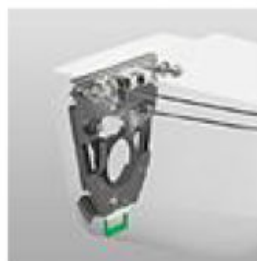

Simple to install with mounting plate

For more details see separately available technical catalogue

CLEANET NAVIA

Focused on the essential, and uncompromisingly hygienic – the Cleanet Navia is the quintessential shower toilet. A well-thought-out operating concept, the focus on core functions, and its timeless design make it the ideal introduction into the world of integrated shower toilets. Featuring simple everyday practicality, from thorough yet gentle bodily hygiene to effective cleaning, it is very convincing.



CLEANET NAVIA shower toilet, „rimless“

CLEANET NAVIA



CLEANET NAVIA shower toilet, „rimless“ KARTELL BY LAUFEN shelves „Shellfish“



Minimised compact design, thanks to closed ceramic body



Hygienic and exchangeable nozzle and cover ring



LCC surface refinement and no flushing rim



Informative LED indicator light



Intuitive operation via rotary button or app

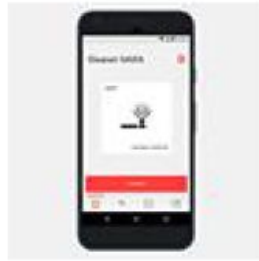

Full access via app



Powerful yet gentle shower spray up to 3.5 l/min



Integrated descaling programme



Pre-mounted, concealed LAUFEN assembly system



Removable WC seat and cover with lowering system

FLORAKIDS Design by Andreas Dimitriadis

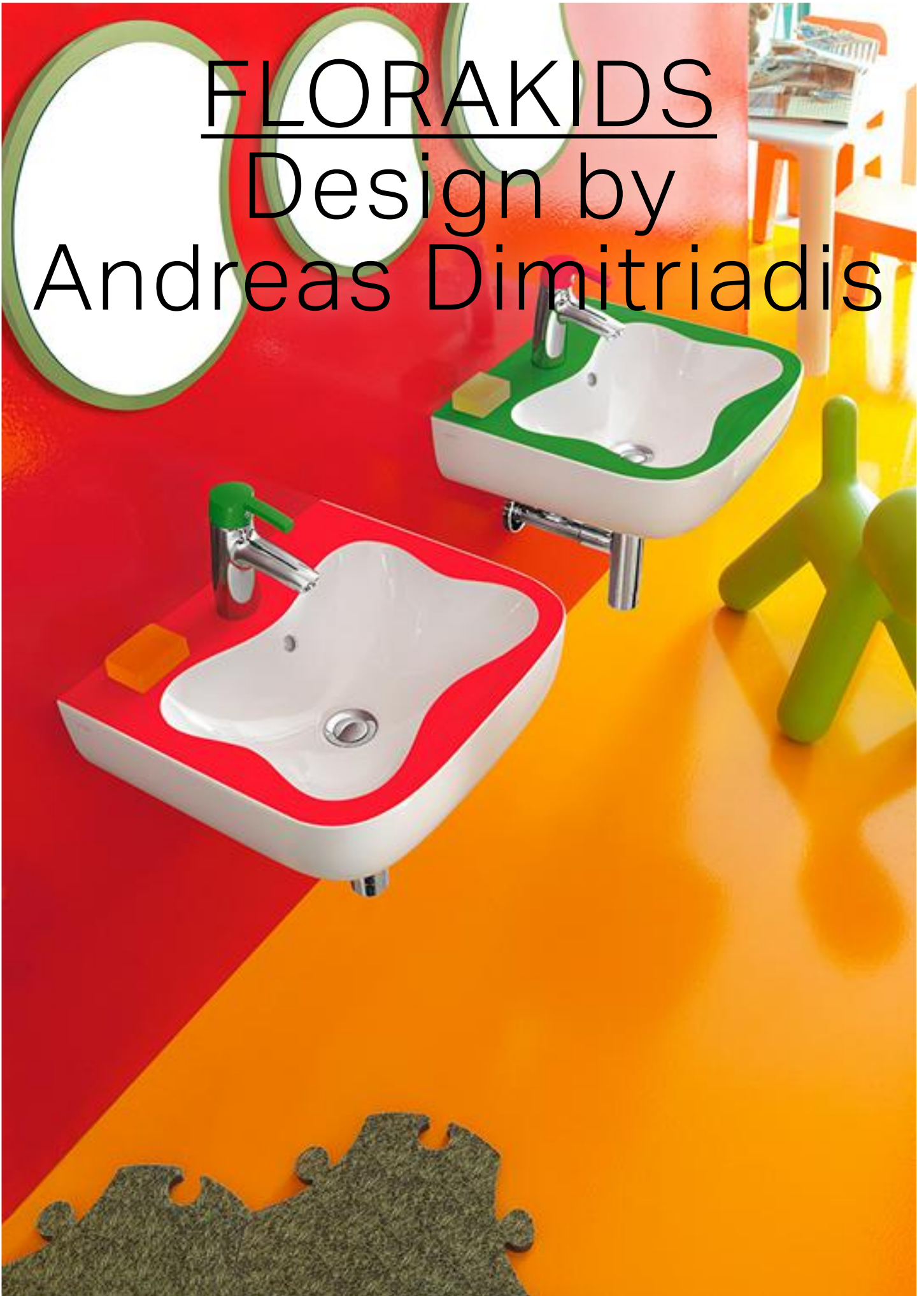

FLORAKIDS washbasin 'cloud' CURVEPRO basin mixer

WITH ATTENTION TO DETAIL!

Smiling children are the summer of life. At any time, anywhere. With FLORAKIDS, by designer Andreas Dimitriadis, the bathroom becomes a space to unfold in, promoting the development and imagination of children. It is meeting the needs of small children with its imaginative positioning.



FLORAKIDS washbasin 'cloud'; shelf 'cloud' CURVEPRO basin mixer

FLORAKIDS



Washbasin 'cloud'

450 x 410 x 140 mm

H815031



Wall-hung WC, washdown, with flushing rim

520 x 310 x 300 mm

H820031



Floorstanding WC, washout, with flushing rim, outlet horizontal / vertical

385 x 295 x 350 mm

H822036 / H822037



WC seat and cover, removable, stainless steel hinges, matches wall-hung WC 820031

H891030 / H891031



WC seat 'ergo', without cover, removable, stainless steel hinges

H891032



Shelf 'cloud', made from sanitary ceramic, wall-hung

550 x 130 x 55 mm

H877031



Mirror 'flower'

435 x 21 x 383 mm

H461601



Mirror 'caterpillar head'

262 x 21 x 296 mm

H461611



Mirror 'caterpillar body'

328 x 21 x 375 mm

H461612



CURVEPRO

Single lever basin mixer, projection 110 mm, fixed spout, with / without pop-up waste, with green lever

H3116510141101 / H3116510141111



CURVEPRO

Single lever basin mixer, projection 110 mm, fixed spout, with / without pop-up waste with red lever

H3116510241101 / H3116510241111

Colours Washbasin 815031

	.000 White
	.062 White and Red
	.072 White and Green

Colours WC 820031

	.000 White
--	----------------------

Colours Seats

	.300 White
	.061 Red
	.071 Green

Colours Faucets

	.014 with green handle
	.024 with red handle

For more details see separately available technical catalogue



FLORAKIDS wall-hung WC



CURVEPRO basin mixer



FLORAKIDS washbasin 'cloud'; wall-hung WC CURVEPRO basin mixer

BARRIER-FREE BATHROOM



PRO LIBERTY washbasin 60, barrier-free LIBERTY PRO basin mixer, barrier-free



PRO LIBERTY wall-hung WC 'rimless', barrier-free; WC seat, barrier-free LIBERTY PRO shower mixer, barrier-free
LAUFEN SOLUTIONS MARBOND shower tray

LAUFEN PRO LIBERTY / LIBERTY LINE / REHAB

Liberty: highly prized in our society, but also, increasingly, a basic need in bathroom design. With his answer to the demand of barrier-free comfort, Peter Wirz proves that the legendary LAUFEN PRO bathroom series knows no limits - even when norms apply.





PRO LIBERTY washbasin 60, barrier-free LIBERTY PRO basin mixer, barrier free



PRO LIBERTY washbasin 65, barrier-free; wall-hung WC 'rimless'

PRO LIBERTY / LIBERTY LINE / REHAB



LIBERTY LINE washbasin without overflow 80; wall-hung WC LIBERTY PRO basin mixer



LIBERTYLINE washbasin without overflow 80 LIBERTY PRO basin mixer



REHAB washbasin without overflow 66 LIBERTY PRO basin mixer

BARRIER-FREE ACCORDING TO GERMAN DIN STANDARD

Standards 18024 and 18025 define the requirements which bathrooms and toilets need to receive in order to be certified ‚DIN barrier-free‘.

The LIBERTY LINE range has been certified as „DIN barrier-free“ and includes a wheelchair-compatible washbasin without overflow hole and a concealed siphon. The toilet, which must be at least 5 cm higher, has a projection of 70 cm and can be wall-mounted using existing connections.

PRO LIBERTY / LIBERTY LINE / MODERNA R

THE UNOBSTRUCTED BATHROOM

Demographic change has brought the needs of older people to the fore. At the same time, it has become clear that planning is beneficial for all generations. In general, a barrier-free bathroom provides greater safety and comfort and is an investment for the future. As a rule, virtually all LAUFEN products are suitable for a bathroom for all age groups. Depending on the place of use and target group, however, particular regulations and guidelines must be adhered to.

Planning for all ages and apartments for the elderly

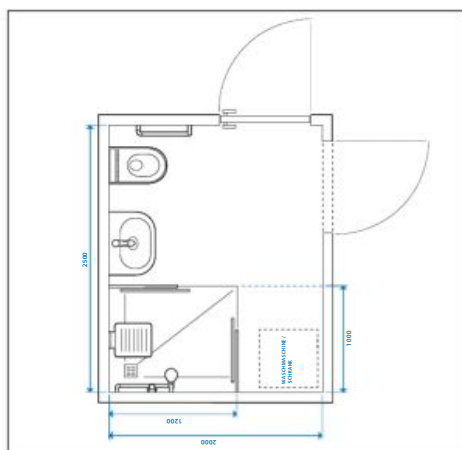

Planning for all ages means creating value for everyone. A bathroom for every age is characterised by a generous, floor level shower with easy-to-operate faucets and shower sliding bar, a washbasin which is suitable for wheelchair access with ergonomic faucets and a toilet mounted at 0.46 m (upper edge of toilet seat).

Toilets in public buildings

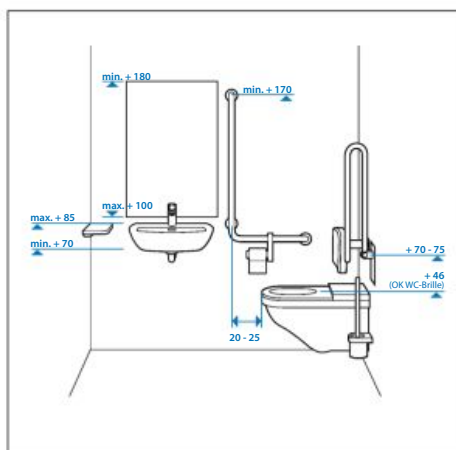

For the planning of public toilets, for example restaurants, office buildings, shopping centres or sports facilities, certain norms have to be adhered to. They define the exact fitting and positioning.

Retirement and care homes

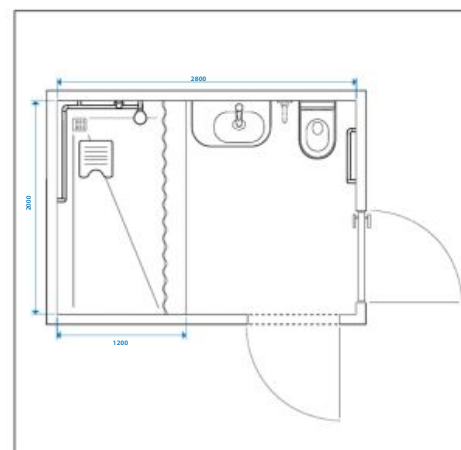

In retirement and care homes, rooms and showers must be generously planned in order to enable people with mobility difficulties to independently care for themselves. For the care of people with disabilities or overweight people two caregivers should also be able to access the bathroom and shower.

TOILET

The toilet should generally be mounted at a height of 0.46 m (upper edge of toilet seat). Placing it in the corner of the bathroom with a centre distance of 0.45 m - 0.50 m will enable the installation of an L-shaped handle on the lateral wall. Toilets in public buildings sometimes require a projection of at least 0.65 m. This can be achieved with an extended LIBERTY toilet, a wall-mounted toilet or a standard concealed toilet on a short front wall installation.

FAUCETS

The longer the lever of the faucet the less force is required to operate it. Various series of Laufen faucets can be re-fitted with a longer handle at a later stage. Contact-free fittings require no use of force and are also suitable. In the shower a concealed faucet is recommended. This facilitates the use of the close handle.



PRO LIBERTY wall-hung WC UNIVERSAL ceramic toilet roll holder; ceramic toilet brush holder

BARRIER-FREE BATHROOM



PRO LIBERTY
Washbasin ,liberty', barrier-free

600 x 550 x 150 mm
H811950



PRO LIBERTY
Washbasin ,liberty', barrier-free

650 x 550 x 160 mm
H811953



PRO LIBERTY
Wall-hung WC ,liberty', washdown,
rimless, barrier-free

700 x 365 x 335 (450) mm
H821960



PRO LIBERTY
Wall-hung WC ,liberty', washdown,
rimless, barrier-free

700 x 360 x 350 (450) mm
H821954



LIBERTYLINE
Washbasin ,liberty', without overflow
and opening in the pop-up waste,
barrier-free

800 x 550 x 150 mm
H811478



LIBERTYLINE
Wall-hung WC ,liberty', washdown, with
flushing rim, barrier-free

700 x 360 x 360 mm
H821470



LIBERTYLINE
WC seat and cover, removable

H892470



LIBERTYLINE
WC seat without cover, ,liberty', remo-
vable, barrier-free

H891470



LIBERTY PRO
Wall-mounted single lever bath mixer
,liberty', with 2-way diverter, with
accessories

H3219570041381



LIBERTY PRO
Wall-mounted single lever shower
mixer ,liberty', with one outlet, with
accessories

H3319570041381

BARRIER-FREE BATHROOM



PRO LIBERTY

Wall-hung WC ,liberty', washdown, with flushing rim, barrier-free

700 x 360 x 350 (450) mm

H820954



PRO LIBERTY

Wall-hung WC ,liberty', washout, with flushing rim, barrier-free

700 x 360 x 350 (450) mm

H820953



PRO LIBERTY

WC seat with / without cover ,liberty', barrier-free, with extra strong hinges and buffers

H898950 / H898951



REHAB

Hospital washbasin ,liberty', barrier-free

660 x 550 x 165 mm

H810603



LIBERTY PLUS

Single lever basin mixer ,liberty', fixed spout 110 mm, with gerontológica lever, with / without pop-up waste

**H3116010041111 /
H3116010041101**



LIBERTY PLUS

Single lever basin mixer ,liberty', swivel spout 145 mm, with gerontológica lever, with / without pop-up waste

**H3116010042211 /
H3116010042201**



LIBERTY PRO

Single lever basin mixer ,liberty', projection 140 mm, fixed spout, cartridge with limitation, without / with pop-up waste

**H3119510045201 /
H3119510045211**



LIBERTY PRO

Wall mixer ,liberty', projection 175 / 225 mm, swivel spout, gauge 134-166 mm, cartridge with flow limiter

**H3119570045201 /
H3119570045301**

SIPHONIC TOILETS

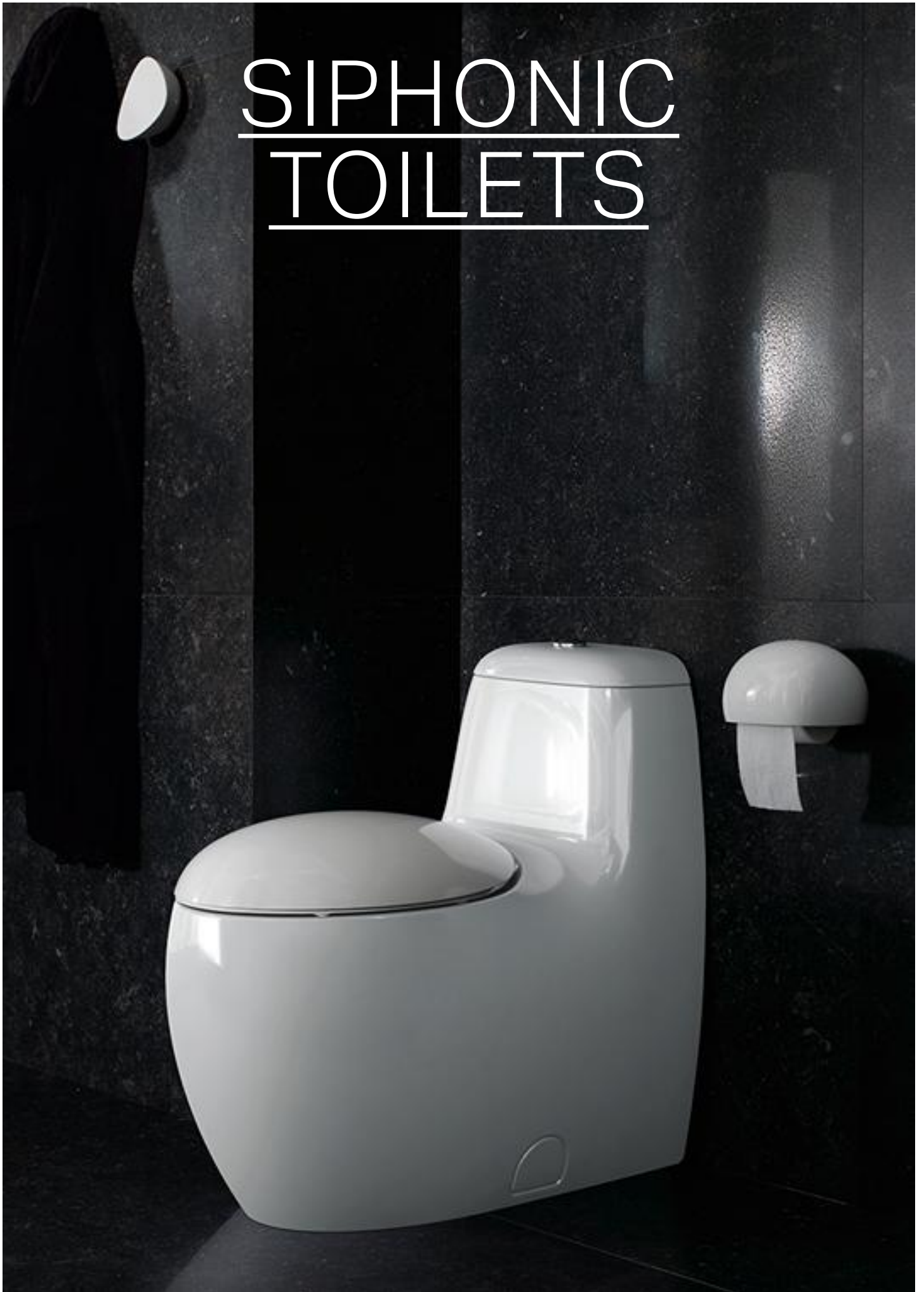

ILBAGNOALESSI ONE one piece toilet; toilet roll holder; towel holder

SIPHONIC TOILETS

Hygienic and practical. These toilets are often referred to as 'masterpiece' as their shape, often in one single cast, makes them difficult to produce. Their siphonic action means water and waste are vacuumed out, which makes them very efficient.



ILBAGNOALESSI ONE

One-piece WC, siphonic action, single flush / dual flush, including seat and cover, removable, with lowering system
745 x 405 x 730 mm

H823971 / H823970



BIROVA

One-piece WC, siphonic action, dual flush, including seat and cover, removable, with lowering system
710 x 360 x 750 mm

H823955



LAUFEN PRO

One-piece WC, siphonic action, dual flush, including seat and cover, removable, with lowering system
715 x 365 x 730 mm

H823953



LAUFEN PRO

Two-piece WC, siphonic action, dual flush

650 x 360 x 440 (430) mm

H825960



SAVOY

One-piece floorstanding WC, siphonic action, dual flush, including seat and cover, removable, with lowering system
750 x 380 x 720 mm

H823948



ARION

One-piece WC, siphonic action, dual flush, including seat and cover, removable, with slow lowering system
735 x 365 x 705 mm

H823560



BIROVA one piece toilet



LAUFEN PRO one piece toilet

UNIVERSAL CISTERN



LAUFEN PRO floorstanding WC combination UNIVERSAL floorstanding cistern

THE ALLROUNDER FOR FLOORSTANDING WCS

The floorstanding universal cistern is characterised by its rectangular geometric design and its high functionality. Its simple cuboid shape can be unobtrusively integrated into the spatial geometry of the bathroom, elegantly disguising the sanitary technology for the WC - the water inlet, cistern and outlet are all fully hidden inside the ceramic housing. The minimalist design fully harmonises with the wide range of floorstanding WCs offered by LAUFEN.

However, the Universal cistern is not just a pretty face. As an interface between the WC and the water supply and drainage installations, it also contains all standard connection options. It is thus eminently suitable for new builds, renovation projects and bathroom conversions. Under normal circumstances, installation will not require any structural changes or interventions. When it comes to cleanliness and hygiene, the robust ceramic housing of the Universal cistern has many bathroom advantages.



Floorstanding cistern, two-part, side water inlet (left or right) / rear inlet (left top) / inlet on the left side or at the bottom / inlet on the right side or at the bottom
400 x 140 x 980 mm

H829660 / H829661 / H829663 / H829664



Floorstanding cistern, side water inlet (left or right) / rear water inlet (left top) / water inlet on the left side or at the bottom / on the right side or at the bottom
400 x 140 x 980 mm

H828660 / H828661 / H828663 / H828664

Colours **Ceramic**

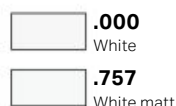

Matching floorstanding WCs can be found in the chapters SONAR, THE NEW CLASSIC, PALOMBA COLLECTION, KARTELL BY LAUFEN and INO.

SPECIAL
ARTICLES /
CERAMIC
ACCESSORIES



BERNINA wall-hung sink with sink grating

OPTIMISED HYGIENE AND CLEAR LINES

Sanitary ceramic used in public buildings is subject to much greater stress than at home. You have to look far for it: High-quality accessories made of ceramics, which give the bathroom a lot of elegance and sovereignty. In addition, practical ceramic fixtures create easy-to-clean storage surfaces.



COLLEGE school washbasin with tap bank and soap dish



UNIVERSAL ceramic toilet brush holder; ceramic toilet roll holder



LIVING SQUARE washbasin 130, cuttable of to 650mm



UNIVERSAL ceramic shelf



COLLEGE
School washbasin with tap bank and soap dish

600 x 455 x 225 mm

H857600



BERNINA
Wall-hung sink basin, with rim flushing, internal water inlet, internal outlet horizontal, with sink grating, chromed

505 x 510 x 710 mm

H854211



ILBAGNOALESSI ONE
Ceramic shelf, with towel slot

630 x 175 x 50 mm

H870972



ILBAGNOALESSI ONE
Ceramic towel holder

130 x 70 x 95 mm

H870976

For more details see separately available technical catalogue



LAUFEN PRO B washbasin 60 UNIVERSAL shelf CITYPRO basin mixer

SPECIAL ARTICLES / CERAMIC ACCESSORIES



ILBAGNOALESSI ONE
Ceramic toilet roll holder

185 x 150 x 110 mm
H870970



THE NEW CLASSIC
Ceramic Mirror with LED ambient light

500 x 80 x 700 mm
H406070



THE NEW CLASSIC
Ceramic shelf

420 x 160 mm
H877851



THE NEW CLASSIC
Ceramic toilet brush holder, incl. toilet brush

105 x 95 x 125 mm
H873852



THE NEW CLASSIC
Ceramic tooth brush holder, incl. mounting material

145 x 125 x 145 mm
H873854



THE NEW CLASSIC
Ceramic soap dish

140 x 115 x 35 mm
H873856



THE NEW CLASSIC
Ceramic soap dispenser

180 x 125 x 145 mm
H873855



VAL
Storage tray, round

325 x 325 x 60 mm
H870281



VAL
Storage tray, rectangular

360 x 280 x 60 mm
H870282



VAL
Toilet roll holder, right / left

170 x 130 x 115 mm
H872280 / H872281



VAL
Toilet brush holder incl. toilet brush

150 x 100 x 360 mm
H872282



PALACE/LIVING SQUARE
Shelf, made from sanitary ceramic, wall-hung, cutable to 650 mm

900/1200/1300/1500/1800x380x35(100)mm
H870433 / H870434 / H870435 / H870436 / H870438



UNIVERSAL
Shelf, made from sanitary ceramic

400 / 500 / 600 x 135 x 65 mm
H870250 / H870252 / H870254



UNIVERSAL
Ceramic WC toilet brush holder, incl. toilet brush

180 x 90 x 105 mm
H873680



UNIVERSAL
Ceramic toilet roll holder

95 x 140 x 95 mm
H872610

Colours Ceramic MODERNA R*

	.000 White
	.018 Bahama beige
	.037 Manhattan
	.049 Pergamon
	.400 White with LCC (LAUFEN Clean Coat)

* not all models are available in all colors. More details on the technical pages or on our website.

LIS - LAUFEN INSTALLATION SYSTEM



VAL small washbasin TWINTRONIC concealed basin mixer with electronic control LEMA urinal CINTO urinal divider LIS installation system

LAUFEN INSTALLATION SYSTEM

Plans might vary, the LAUFEN Installation System is fixed. With a self-supporting steel frame it is suitable for every construction situation and most different installation scenarios. It is the perfect solution, when it comes to installing washbasins, toilets, shower toilets, bidets or urinals quickly, securely and economically.

NEW FACE-MOUNTED INSTALLATION SYSTEM FOR URINALS.

The LIS LAUFEN installation system is the perfect solution for safe, quick, and simple installation of urinals by LAUFEN. The range includes various different urinal elements for dry and wet installation.

The most varied installation scenarios can be achieved with their help. The surface mounting elements are also available with a pre-assembled control box by Sanimatic for urinals without a built-in control unit. As a network version, the control box contains a Bluetooth-module for the upkeep and maintenance of the basic settings via SmartControl App (iOS & Android).



SmartControl function video

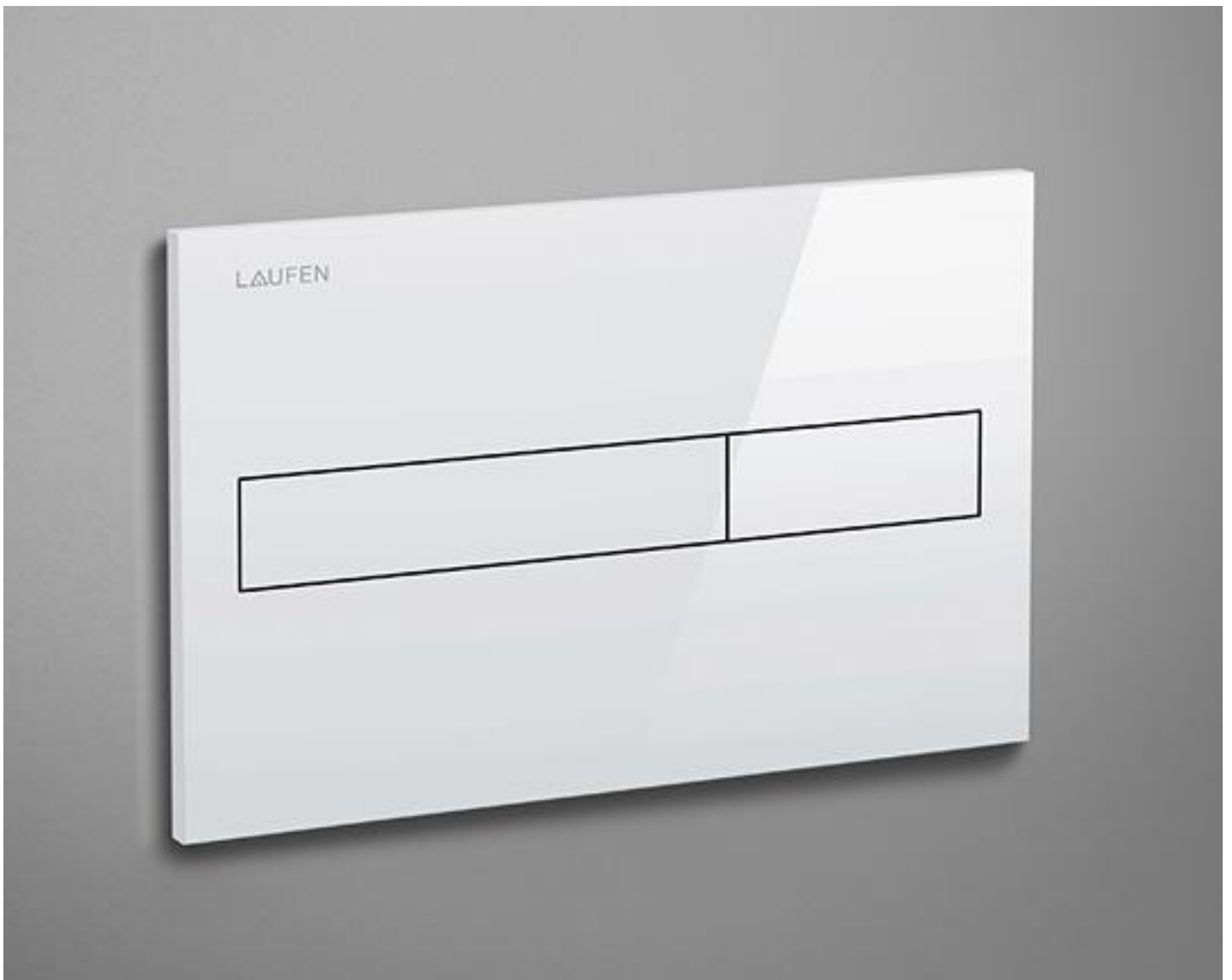

LIS flush plate AW1, white



New: Two electronic, sensor-controlled glass flush plates AW3 and AW4 in two graphic designs available in black and white

LIS INSTALLATION SYSTEMS AND FLUSH PLATES



Installation system LIS CW2 with cistern for wall-hung WC and shower toilet, dual flush 6/3L resp. 4.5/3L
500 x 140-195 x 1120-1320 mm
H894661 / H894666



Installation system LIS CW1 with cistern for wall-hung WC, dual flush 6/3L
500 x 140-195 x 1120-1320 mm
H894660 / H894665



Freestanding installation system LIS CW3 with cistern for wall-hung WC, dual flush 6/3L
500 x 140-195 x 1120-1320 mm
H894662



Concealed cistern for wall-hung WC and floorstanding WC pan, dual flush 6/3L
530 x 200 x 720 mm
H894664



Installation system LIS TW1 for brick wall installation with cistern for wall-hung WC, dual flush 6/3L
450 x 125 x 770 mm
H894663



Flush plate AW1, dual flush
250 x 10 x 160 mm
H895661



Flush plate Inox AW2, dual flush, vandalproof
250 x 10 x 160 mm
H895662



Electronic glass flush plate AW3, contactless, dual flush
250 x 15 x 160 mm
H895663



Electronic glass flush plate AW4, contactless, dual flush
250 x 15 x 160 mm
H895664

Colours Flush plate AW1

	.000 White
	.004 Chromed
	.007 Chromed matt
	.716 Black matt

Colours Flush plates AW3 + AW4

	.000 White
	.020 Black glossy

Colours Flush plate AW2

	.000 Inox brushed
--	-----------------------------



CH1 installation element for grip and restraint systems, left / right
295 x 135-205 x 1120-1320 mm
H892667 / H892668



Installation system LIS CB1 for wall-hung bidets
525 x 135-205 x 1120-1320 mm
H892660



Installation system LIS CWB1 for basins
500 x 130-195 x 1120-1320 mm
H892661



Mounting plate for Simibox, light' for LIS CWB1
H892662



Installation system LIS CU1 / CU2 for urinals without integrated control unit
500 x 140-195 x 1440-1640 mm
H892663 / H892664

For more details see separately available technical catalogue

LIS INSTALLATION SYSTEMS AND FLUSH PLATES



Installation system LIS CU3 for urinals with integrated control unit or waterless

500 x 140-195 x 1325-1625 mm

H892665



Urinal control system, cover with IR sensor and mounting frame, with Bluetooth adapter, mains version

118 x 8.5 x 144 mm

H370660004xxx1



PRO S wallhung WC LIS Installation System

BATHROOM FURNITURE



VAL drop-in washbasin; wall mixer BOUTIQUE made-to-measure countertop; freestanding drawer element 90 FRAME 25 mirror



POSSIBLE COMBINATIONS





















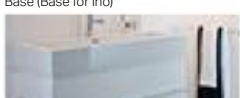





















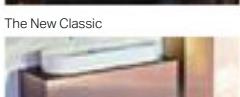





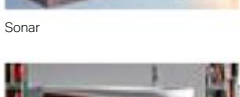

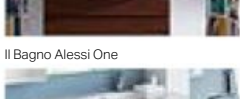





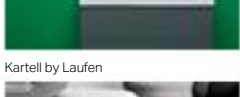

Ceramics - furniture combination options

	Laufen ceramic series Bowl washbasins; washbasins, undersurface ground												
Laufen furniture programs Vanity units, washtops for furniture washbasins and tabletop washbasins	The New Classic	Sonar	Il Bagno Alessi One	Palomba Collection	Kartell by Laufen	Living City	Living Square	Living SaphirKeramik	Ino	Val	Palace	Laufen Pro S	Laufen Pro A/B
Boutique	•	•		•	•			•	•	•			
Base										•		•	
Case				•		•	•				•	•	•
Case washtops				•	•	•	•	•	•	•		•	•
Space										•			
Space washtops				•	•	•	•	•	•	•		•	•
The New Classic	•												
Sonar		•											
Il Bagno Alessi One			•										
Palomba Collection				•									
Kartell by Laufen					•								
Ino									•				
Laufen Pro S												•	
Laufen Pro													•

OVERVIEW FURNITURE COLOURS

Standard colours

Multicolour

						
Boutique	Light oak	Dark oak				
						
Base (Base for Ino)	White matt	White glossy	Light elm	Dark brown elm	Oyster white	Traffic grey
						
Case	White matt	White glossy	Light elm	Dark brown elm		
						
Case Waschtischplatten	White matt	White glossy	Chalked oak	Anthracite Oak		
						
Space	White matt	Light walnut	Dark elm			
						
Space Waschtischplatten	White matt	Light walnut	Dark elm			
						
The New Classic	White glossy	Traffic grey	Blacked Oak			
						
Sonar	Gold	Copper	Titanium	Gold & Nero marquina	Copper & Nero marquina	Titanium & Nero marquina
						
Il Bagno Alessi One	White glossy	Noce Canaletto				
						
Palomba Collection	White	Cherry Vermont dark				
						
Kartell by Laufen	White matt	Pebble grey	Slate grey			
						
Ino	White matt	Dark walnut				
						
Laufen Pro S	White matt	White glossy	Graphite	Wenge (structured)	Bright oak	
						
Laufen Pro	White	White glossy	Wenge (structured)			



Not all colours available for all models

BOUTIQUE



INO washbasin, undersurface ground; bathtub KARTELL BY LAUFEN basin mixer; column bath mixer
BOUTIQUE drawer element 90; medium cabinet and medium cabinet with open front FRAME 25 mirror

DESIRE - THE MEASURE OF ALL THINGS

No furniture series could enhance a bathroom more surprisingly. In the BOUTIQUE range, the highest quality materials and wood finishes have been strategically selected with great care and technical finesse to ensure they meet the needs of the most discerning customer. Here, the characteristics of the trend-setting SaphirKeramik are reflected in the fine design language. Narrow, tapered edges provide perfectly shaped storage space in the bathroom which harmonises immaculately with the fine washbasin shapes. The crowning glory is the user-friendliness of the sophisticated design with seemingly incidental, intelligent technical solutions.



BOUTIQUE



VAL washbasin 95 BOUTIQUE drawer element 120 KARTELL BY LAUFEN basin mixer



BOUTIQUE tall cabinet; drawer element



KARTELL BY LAUFEN bowl washbasin; basin mixer
BOUTIQUE countertop; drawer element FRAME 25 mirror



LIVING SAPHIRKERAMIK bowl washbasin
BOUTIQUE countertop; drawer element

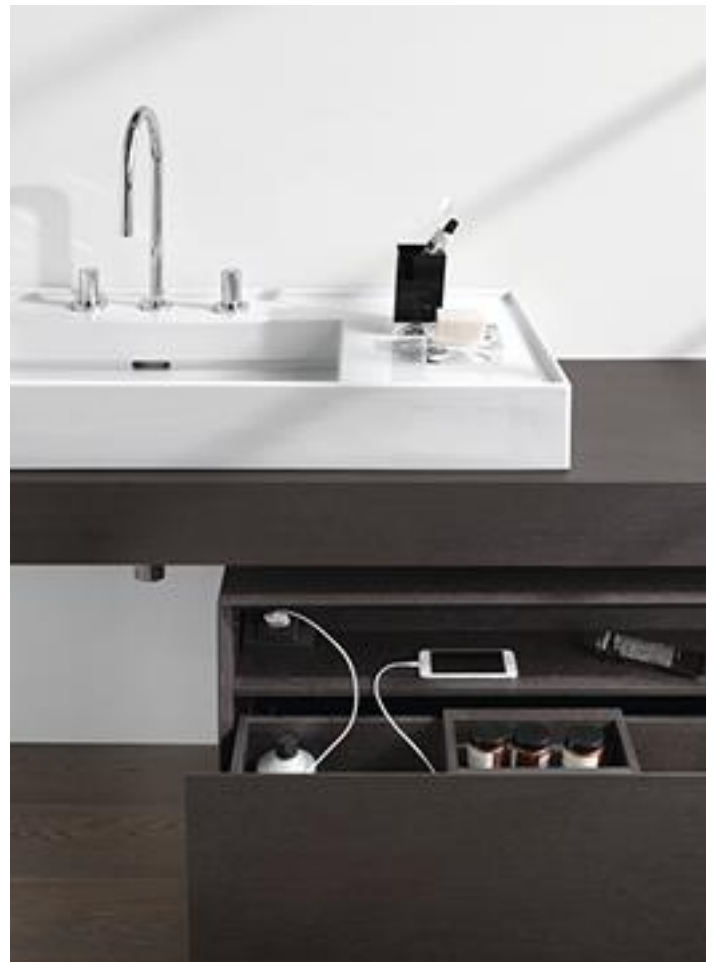

KARTELL BY LAUFEN washbasin 90, undersurface ground; basin mixer
BOUTIQUE countertop; drawer element with organiser

BOUTIQUE



Drawer element 900, 1 drawer without / with centre cut-out

900 x 380 x 360 mm

H409003 / H409000



Drawer element 900, 1 drawer without / with centre cut-out

900 x 500 x 430 mm

H409013 / H409010



Drawer element 1200, 1 drawer, without / with centre cut-out

1200 x 380 x 360 mm

H409033 / H409030



Drawer element 1200, 1 drawer, with cut-out left / right

1200 x 380 x 360 mm

H409031 / H409032



Base for drawer element 900x500 mm (for floor mounting)

820 x 460 x 40 mm

H409230



Base for drawer element 1200x500 mm (for floor mounting)

1120 x 460 x 40 mm

H409235



Countertop, made-to-measure, 600-2200 mm, 80/120 mm thick

600-2200 x 500 x 80/120 mm

H409220



Organiser for drawer, small

195 x 250 x 55 mm

H409200



Medium cabinet, open front

300 x 300 x 900 mm

H409170



Open shelf element

300 x 380 x 360 mm

H409100



Open shelf element

300 x 500 x 430 mm

H409101



Internal shelf for drawer element 900 x 380 mm, with provision for a socket

865 x 90 x 85 mm

H409241

Colours Towel holder CASE



.104

Anodised aluminium, glossy



.105

Anodised aluminium



.106

Anodised aluminium, dark brown



CASE

Towel holder for furniture, 270 / 320 / 400 mm

270 / 320 / 400 x 60 x 15 mm

H490950 / H490951 / H490952

For more details see separately available technical catalogue



Drawer element 1200, 1 drawer, with cut-out left and right

1200 x 380 x 360 mm

H409034



Drawer element 1200, 1 drawer, without / with centre cut-out

1200 x 500 x 430 mm

H409053 / H409050



Drawer element 1200, 1 drawer, with cut-out left / right

1200 x 500 x 430 mm

H409051 / H409052



Drawer element 1200, 1 drawer, with cut-out left and right

1200 x 500 x 430 mm

H409054



Organiser for drawer, big

275 x 250 x 55 mm

H409201



Socket module, IP 44, matches L shaped shelves 409241, 409242, 409245, 409246

100 x 70 x 70 mm

H492984



Tall cabinet, 1 door, left or right hinged, with 4 wooden shelves

300 x 300 x 1800 mm

H409131



Medium cabinet, 1 door, left or right hinged, with 2 wooden shelves

300 x 300 x 900 mm

H409151

Colours **Furniture**



Internal shelf for drawer element 900 x 500 mm, with provision for a socket

865 x 150 x 85 mm

H409242



Internal shelf for drawer element 1200 x 380 mm, with provision for a socket

1165 x 90 x 85 mm

H409245



Internal shelf for drawer element 1200 x 500 mm, with provision for a socket

1165 x 150 x 85 mm

H409246

Matching mirrors and mirror cabinets can be found for example in the FRAME 25 / LEELO chapters.

SPACE



VAL washbasin 120; wall mixer SPACE vanity unit FRAME 25 mirror

INTERIOR DESIGN HAS NEVER BEEN EASIER

SPACE defines an area with the characteristics that LAUFEN has been using since the invention of SaphirKeramik. Strong lines and narrow edge radii characterise the shape, while fine materials and high-quality technology ensure convenience. With 39 colours, 76 versions of furniture, and countless ceramics combinations, the only thing that is difficult is making a decision.



VAL washbasin 120 SPACE vanity unit; drawer element with organiser

SPACE



LIVING CITY bowl washbasin 90 SPACE countertop; drawer element 60 FRAME 25 mirror



SPACE tall cabinet with mirrored front, 4 shelves; tall cabinet ,slim' with open front, 4 shelves



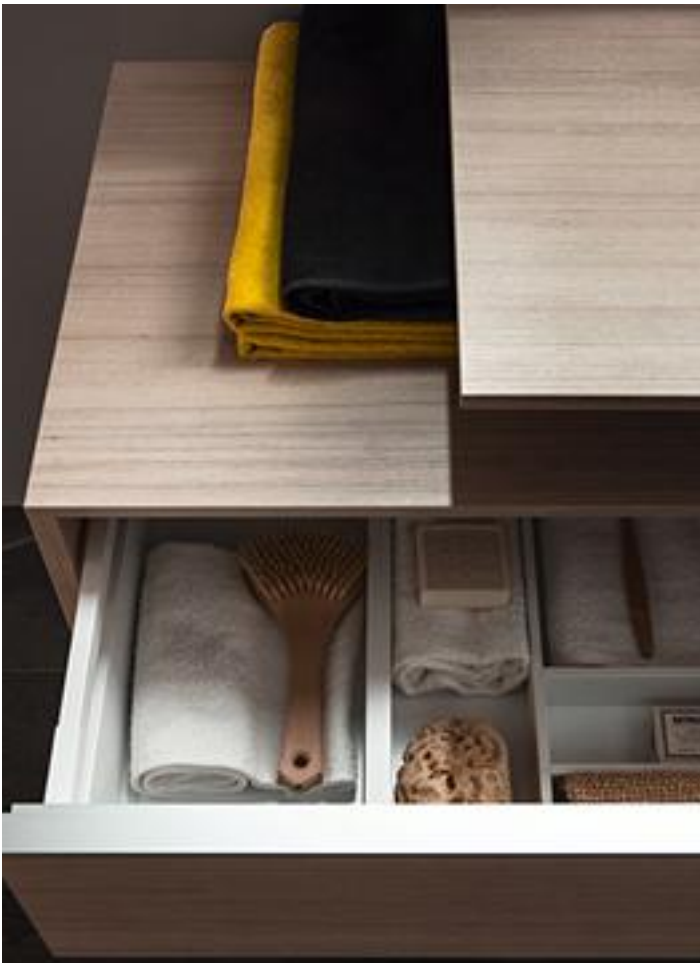

SPACE countertop; drawer element with organiser



PRO S washbasin 60; wall-hung WC
SPACE countertop; drawer element; tall cabinet; slim tall cabinet
FRAME 25 mirror cabinet CITY PLUS basin mixer



VAL washbasin 55 SPACE vanity unit; tall cabinet with open front
FRAME 45 mirror CASE towel holder CITYPLUS basin mixer

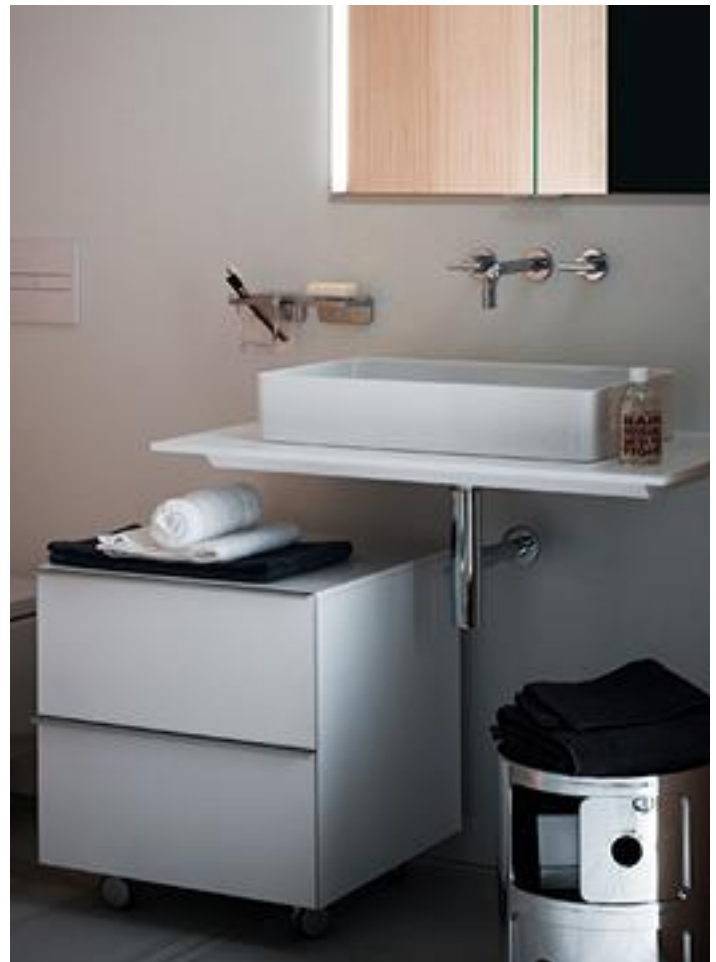

LIVING SAPHIRKERAMIK bowl washbasin, rectangular
SPACE countertop; trolley FRAME 25 mirror cabinet

SPACE



Countertop, 900 mm, 13 mm thick,
without / with centre cut-out

870 x 520 x 13 mm

H410950 / H410953



Countertop, 1200 mm, without / with
centre cut-out

1170 x 520 x 13 mm

H411000 / H411003



Countertop, 1200 mm, with cut-out
left / right

1170 x 520 x 13 mm

H411001 / H411002



Countertop, 1200 mm, with cut-out left
and right, 13 mm thick

1170 x 520 x 13 mm

H411004



Countertop, made-to-measure, 600-
2200 mm, 100 mm thick

600-2200 x 520 x 100 mm

H411090



Organiser ,small', for vanity unit, lac-
quered matt white

200 x 274 x 45 mm

H495401



Organiser ,small', for drawer element
and trolley, lacquered matt white

200 x 374 x 45 mm

H495403



Organiser ,big', for vanity unit, lacque-
red matt white

320 x 274 x 45 mm

H495405



Trolley, 2 drawers

535 x 520 x 580 mm

H411192



Tall cabinet with open front, 4 shelves

300 x 295 x 1700 mm

H410900



Tall cabinet with mirrored front, left or
right hinged, 4 shelves

300 x 300 x 1700 mm

H410901



Tall cabinet ,slim' with open front, 4
shelves

150 x 295 x 1700 mm

H410905

Colours **Handles / Feets**



.004

Chromed

please add color code of furniture, towel holder and feets
to the order form



Organiser ,small', small depth, for vani-
ty unit, lacquered matt white

200 x 245 x 45 mm

H495400



Organiser ,small', small depth, for
drawer element and trolley, lacquered
matt white

200 x 325 x 45 mm

H495402



Organiser ,big', small depth, for vanity
unit, lacquered matt white

320 x 245 x 45 mm

H495404

For more details see separately available technical catalogue



Countertop, 1600 mm, without / with centre cut-out

1580 x 520 x 13 mm

H411050 / H411053



Countertop, 1600 mm, with cut-out left / right

1580 x 520 x 13 mm

H411051 / H411052



Countertop, 1600 mm, with cut-out left and right, 13 mm thick

1580 x 520 x 13 mm

H411054



Countertop, made-to-measure, 600-2200 mm, 13 mm thick

600-2200 x 520 x 13 (48) mm

H411080



Organiser 'big', for drawer element and trolley, lacquered matt white

320 x 374 x 45 mm

H495407



Drawer element, 450 mm, 1 drawer

435 x 520 x 250 mm

H411101



Drawer element, 600 mm, 1 drawer

585 x 520 x 250 mm

H411131







Drawer element, 800 mm, 1 drawer

790 x 520 x 250 mm

H411161

Colours Furniture

-  **.100**
White matt, with handle aluminium
-  **.101**
Light walnut, with handle aluminium
-  **.103**
Dark elm, with handle dark brown aluminium
-  **.999***
Multicolour (laquered)

* not available for countertops and drawer units

Please state colour number in the order text:



For more information on the choice of 39 colours, refer to the „Product features and benefits“ chapter.





Set of adjustable feet (2 pieces), height 275 mm, anodized aluminium surface

275 mm

H411220

Colours Towel holder CASE

-  **.104**
Anodised aluminium, glossy
-  **.105**
Anodised aluminium
-  **.106**
Anodised aluminium, dark brown



Organiser 'big', small depth, for drawer element and trolley, lacquered matt white

320 x 325 x 45 mm

H495406



CASE

Towel holder for furniture, 270 / 320 / 400 mm

270 / 320 / 400 x 60 x 15 mm

H490950 / H490951 / H490952

Other SPACE furniture can be found in the VAL chapter. Matching mirrors and mirror cabinets can be found for example in the FRAME 25 / LEELO chapters.

CASE



LIVING CITY washbasin 100 CASE for LIVING CITY vanity unit

FURNITURE AND COUNTERTOPS

We choose furniture to set up our homes, express our style and make visual statements. However, it is not just the looks that decide whether a piece of furniture is attractive, but also its feel and functionality. Thoughtfully designed, the CASE range of bathroom furniture, with its minimalistically simple appearance, successfully combines these factors. The style of architectural modernity, scaled back and timeless, leaves all the ceramics centre stage.



LIVING SQUARE washbasin cuttable CASE for LIVING SQUARE vanity unit CASE towel holder TWINPLUS basin mixer

CASE



CASE tall cabinet



PALACE washbasin 60 CASE for PALACE vanity unit; medium cabinet CURVEPRIME basin mixer



CASE vanity unit



CASE for PALACE vanity unit with drawers and doors



LIVING CITY washbasin 100 CASE for LIVING CITY vanity unit



LIVING CITY small washbasin CASE for LIVING CITY vanity unit CASE towel holder

CASE



LAUFEN PRO S washbasin 60, undersurface ground CASE countertop 120 with drawer element; trolley with drawer CITYPLUS basin mixer



LIVING CITY washbasin 60, undersurface ground CASE countertop 90 with drawer element; towel holder; medium cabinet



CASE countertop 180 with drawer element 90 PALOMBA COLLECTION bowl washbasin



CASE for PALACE vanity unit 120 CASE tall cabinet
PALACE washbasin 120 with towel holder
CURVEPRIME basin mixer

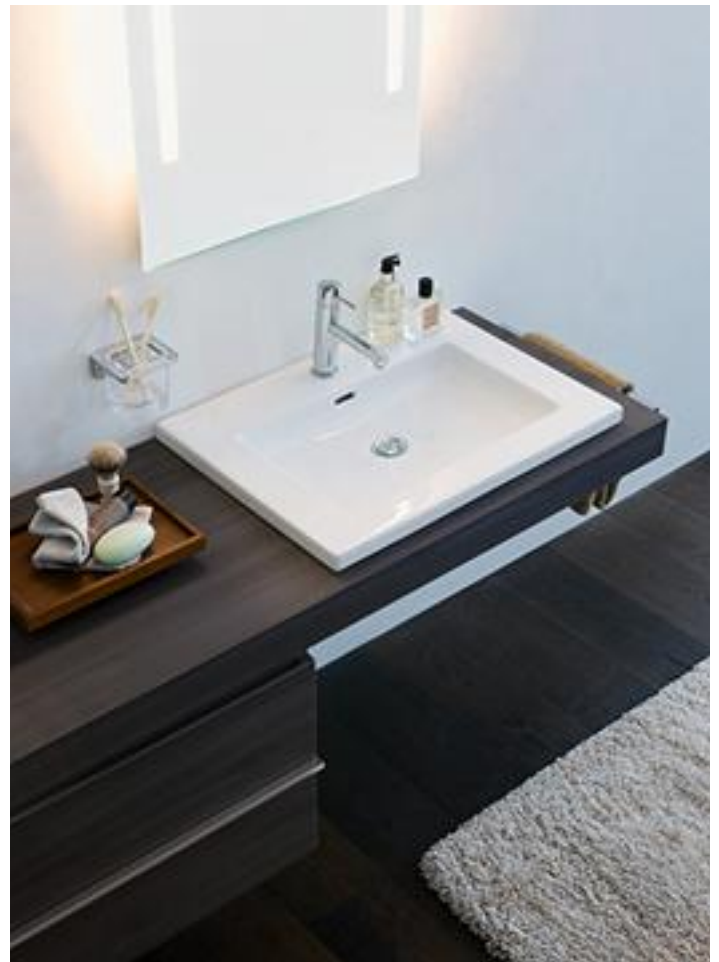

CASE countertop 160 with drawer element 80
LIVING SQUARE drop-in washbasin, wall-mounted

CASE



Countertop, 600 mm, without / with
centre cut-out

595 x 520 x 80 mm

H405110 / H405111



Countertop, 800 mm, without / with
centre cut-out

790 x 520 x 80 mm

H405120 / H405121



Countertop, 900 mm, without / with
centre cut-out

895 x 520 x 80 mm

H405130 / H405131



Countertop, 1200 mm, without / with
centre cut-out

1190 x 520 x 80 mm

H405140 / H405141



Countertop, 1600 mm, with cut-out left
and right

1580 x 520 x 80 mm

H405154



Countertop, 1800 mm, without / with
centre cut-out

1785 x 520 x 80 mm

H405160 / H405161



Countertop, 1800 mm, with cut-out
left / right

1785 x 520 x 80 mm

H405162 / H405163



Countertop, 1800 mm, with cut-out left
and right

1785 x 520 x 80 mm

H405164



Medium cabinet, 2 glass shelves, left /
right hinged

350 x 335 x 1000 mm

H402011 / H402012



Trolley with drawer and additional
interior drawer

460 x 385 x 505 mm

H402051

Colours Towel holder CASE

.104
Anodised aluminium, glossy

.105
Anodised aluminium

.106
Anodised aluminium, dark brown



Towel holder for furniture, 270 / 320 /
400 mm

270 / 320 / 400 x 60 x 15 mm

H490950 / H490951 / H490952

For more details see separately available technical catalogue



Countertop, 1200 mm, with cut-out left / right

1190 x 520 x 80 mm

H405142 / H405143



Countertop, 1200 mm, with cut-out left and right

1190 x 520 x 80 mm

H405144



Countertop, 1600 mm, without / with centre cut-out

1580 x 520 x 80 mm

H405150 / H405151



Countertop, 1600 mm, with cut-out left / right

1580 x 520 x 80 mm

H405152 / H405153



Countertop, made-to-measure, 500-2200 mm

500-2200 x 520 x 80 mm

H405170



Drawer element, 600 / 800 / 900 mm, with 1 drawer

595 x 520 x 230 mm

H405212 / H405222 / H405232



Drawer element, 600 / 800 / 900 mm, with 2 drawers

595 x 520 x 450 mm

H405214 / H405224 / H405234



Tall cabinet, 1 door, 4 glass shelves, left / right hinged

350 x 335 x 1650 mm

H402021 / H402022

Colours Furniture

.463
White matt

.475*
White glossy

.519
Chalked oak

.548
Anthracite oak

.999*
Multicolour (laquered)

Please state colour number in the order text:



For more information on the choice of 39 colours, refer to the „Product features and benefits“ chapter.

* not available for countertops and drawer units



Set of adjustable feet (2 pieces), height 165 / 355 / 337 / 370 / 385 / 410 / 255 mm, anodized aluminium surface 165 / 355 / 337 / 370 / 385 / 410 / 255 mm

H483091 / H483092 / H483093 / H483094 / H483095 / H483096 / H483097 / H483098 / H483099



Set of adjustable feet (2 pieces), height 165 / 355 / 337 / 370 / 385 / 410 / 255 mm, anodized aluminium surface 165 / 355 / 337 / 370 / 385 / 410 / 255 mm

H483091 / H483092 / H483093 / H483094 / H483095 / H483097 / H483098 / H483099

Colours Adjustable feet

.004
Chromed

Other CASE furniture can be found in the LIVING and PALACE chapters.

BASE



PRO S washbasin 120 BASE for PRO S vanity unit BASE mirror cabinet and tall cabinet CITYPRO basin mixer

FURNITURE / MIRROR CABINETS

Time spent in the bathroom is balm for your soul. With BASE, this experience could not be more pleasant. The newest range of bathroom furniture sets the scene, complementing the LAUFEN ceramics collection, to create an aesthetically pleasing experience. With technology suitable for everyday use, a variety of surfaces and a wide range of colours, the range supports even the most ambitious bathroom planning without compromise.



PRO S double washbasin 120 BASE for PRO S vanity unit with 4 drawers CITYPRO basin mixer

BASE



PRO S small washbasin 48 BASE for PRO S vanity unit
FRAME 25 glass shelf CITYPRO basin mixer



VAL washbasin 120; basin mixer
BASE for VAL vanity unit



BASE tall cabinets



VAL small washbasin 45; basin mixer; wall-hung WC „rimless“ BASE for VAL vanity unit
FRAME 25 mirror and glass shelf 45 LIS installation system for wall-hung WCs; flush plate

BASE



PRO S combipack washbasin ,slim' 80 with vanity unit BASE BASE mirror cabinet, tall and medium cabinet
PRO wall-hung WC ,rimless' LIS flush plate CITYPRO basin mixer



BASE for VAL vanity unit VAL washbasin 60



BASE for VAL vanity unit, tall and mirror cabinet
VAL washbasin 60; basin mixer



BASE mirror cabinet 80 with integrated socket and surface-mounted light



BASE tall cabinet with drawer



PRO S combipack washbasin ,slim' 120 with vanity unit BASE BASE tall cabinets PRO wall-hung WC ,rimless'
CITYPRO basin mixer LIS flush plate FRAME 25 mirror and glass shelf



BASE mirror cabinet 60 with integrated socket and surface-mounted light



PRO S combipack washbasin ,slim' with BASE vanity unit



VAL wall-hung WC ,rimless'; combipack, small washbasin 34 with vanity unit ,BASE' LIS flush plate

BASE



Tall cabinet, 1 door, left / right hinged, 1 fixed shelf, 4 glass shelves, design matches vanity units
350 x 335 x 1650 mm
H402671 / H402672



Tall cabinet, 2 doors, left / right hinged, 1 open shelf, 2 glass shelves, design matches vanity units
350 x 335 x 1650 mm
H402691 / H402692



Tall cabinet, 2 doors, left hinged, 1 drawer, 4 glass shelves, design matches vanity units
350 x 335 x 1650 mm
H402711 / H402712



Tall cabinet, with small projection, 1 door, left / right hinged, 1 fixed shelf, 4 glass shelves, design matches vanity units
350 x 185 x 1650 mm
H402641 / H402642



Tall cabinet, 2 doors, left / right hinged, 1 drawer, 4 glass shelves, design matches combipacks
350 x 335 x 1650 mm
H402721 / H402722



Tall cabinet, made-to-measure, 250-450 mm, max. height 1650 mm
250-450 x 335 x <1650 mm
H402730







Wall cabinet, with small projection, 1 door, left / right hinged, design matches combipacks
350 x 185 x 700 mm
H402611 / H402612



Shelf with mirrored front, open-sided right and left, 2 shelves
250 x 185 x 700 mm
H402950

Colours Furniture

-  **.260**
White matt
-  **.261**
White glossy
-  **.262**
Light elm
-  **.263**
Dark elm
-  **.999**
Multicolour (laquered)

Please state colour number in the order text:



For more information on the choice of 39 colours, refer to the „Product features and benefits“ chapter.

Colours Adjustable feet

-  **.004**
Chromed



Set of adjustable feet (2 pieces), height 264 / 283 / 293 mm, anodized aluminium surface
264 / 283 / 293 mm
H402990 / H402991 / H402992



Accessories set consisting of a cosmetics mirror, magnetic strip and a storage tray made of transparent plastic

H490600

For more details see separately available technical catalogue



Wall cabinet, with small projection, 1 door, left / right hinged, design matches vanity units
350 x 185 x 700 mm
H402601 / H402602



Tall cabinet, with small projection, 1 door, left / right hinged, 1 fixed shelf, 4 glass shelves, design matches combipacks
350 x 185 x 1650 mm
H402651 / H402652



Tall cabinet, 1 door, left / right hinged, 1 fixed shelf, 4 glass shelves, design matches combipacks
350 x 335 x 1650 mm
H402681 / H402682



Tall cabinet, 2 doors, left / right hinged, 1 open shelf, 2 glass shelves, design matches combipacks
350 x 335 x 1650 mm
H402701 / H402702



Mirror cabinet, 600 mm, 1 door, left / right hinged, with horizontal LED light element, 2 glass shelves, 1 socket
600 x 185 x 700 mm
H402751 / H402752



Mirror cabinet, 800 mm, 2 doors, with horizontal LED light element, 2 glass shelves, 1 socket
800 x 185 x 700 mm
H402802



Mirror cabinet, 1000 mm, 2 doors, with horizontal LED light element, 2 glass shelves, 1 socket
1000 x 185 x 700 mm
H402852



Mirror cabinet, 1200 mm, 2 doors, with horizontal LED light element, 2 glass shelves, 1 socket
1200 x 185 x 700 mm
H402902



Laundry basket for tall cabinets

270 x 270 x 450 mm
H493020





CASE

Towel holder for furniture, 270 / 320 / 400 mm

270 / 320 / 400 x 60 x 15 mm
H490950 / H490951 / H490952

Colours **Towel holder CASE**

-  **.104**
Anodised aluminium, glossy
-  **.105**
Anodised aluminium
-  **.106**
Anodised aluminium, dark brown

FRAME 25



INO vanity washbasin 90, shelf left, matt KARTELL BY LAUFEN basin mixer FRAME 25 mirror

MIRROR CABINETS / MIRRORS / GLASS SHELVING

Timeless elegance is expressed in the FRAME 25 mirrors. They are impressive with their crystal-clear reflection, essential when putting on make-up, for skin care, or shaving. They are protected by a narrow, gloss anodised aluminium frame with cleanly defined edges.



FRAME 25 Mirror cabinet

FRAME 25 Mirror cabinet with socket

FRAME 25



PRO S double washbasin 120; vanity unit; tall cabinet FRAME 25 mirror 120, vertical LED light elements
CITYPLUS basin mixer



FRAME 25 mirror with light sensor



FRAME 25 mirror with light detail



FRAME 25 glass shelf



FRAME 25 Mirror cabinet with socket

FRAME 25



Mirror cabinet, 450 mm, aluminium, 1 door mirrored on both sides, left hinged, with sensor switch, 2 sockets, 2 vertical LED lighting elements (dimnable), without / with ambient light (downward)
450 x 150 x 750 mm

H408301 / H408351



Mirror cabinet, 450 mm, aluminium, 1 door mirrored on both sides, left hinged, without sockets, without sensor switch, 2 vertical LED lighting elements (dimnable), without / with ambient light (downward)
450 x 150 x 750 mm

H408321 / H408371



Mirror cabinet, 450 mm, aluminium, 1 door mirrored on both sides, right hinged, with sensor switch, 2 sockets, 2 vertical LED lighting elements (dimnable), without / with ambient light (downward)
450 x 150 x 750 mm

H408302 / H408352



Mirror cabinet, 450 mm, aluminium, 1 door mirrored on both sides, right hinged, without sockets, without sensor switch, 2 vertical LED lighting elements (dimnable), without / with ambient light (downward)
450 x 150 x 750 mm

H408322 / H408372



Mirror cabinet, 800 mm, aluminium, 2 doors mirrored on both sides, with sensor switch, 2 sockets, 2 vertical LED lighting elements (dimnable), without / with ambient light (downward)
800 x 150 x 750 mm

H408503 / H408553



Mirror cabinet, 800 mm, aluminium, 2 doors mirrored on both sides, with 2 LED lighting elements, without socket, without sensor switch, without / with ambient light (downward)
800 x 150 x 750 mm

H408523 / H408573



Mirror cabinet, 1000 mm, aluminium, 2 doors mirrored on both sides, with sensor switch, 2 sockets, 2 vertical LED lighting elements (dimnable), without / with ambient light (downward)
1000 x 150 x 750 mm

H408603 / H408653



Mirror cabinet, 1000 mm, aluminium, 2 doors mirrored on both sides, without sensor switch, without socket, without sensor switch, without / with ambient light (downward)
1000 x 150 x 750 mm

H408623 / H408673

Colours Mirror cabinets



Accessories set consisting of a cosmetics mirror, magnetic strip and a storage tray made of transparent plastic

190 x 100 x 130 mm

H490600



Mirror with aluminium frame

450 / 550 x 25 x 825 mm

H447400 / H447401



Mirror with aluminium frame

600 / 650 x 25 x 700 mm

H447402 / H447403

Colours Aluminium frame

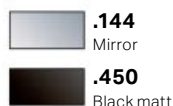

Mirror round, 550 mm / with LED ambient light, for room switch

550 x 23 x 550 mm

H447430 / H447431



Mirror round, 800 mm / with LED ambient light, for room switch

800 x 23 x 800 mm

H447432 / H447433



Installation frame and plate for mirror cabinet 450 - 1300 mm (not for use with mirror cabinets with ambient light)

480 - 1230 x 30 x 780 mm

H408380 / H408480 / H408580 / H408680 / H408880

For more details see separately available technical catalogue



Mirror cabinet, 600 mm, aluminium, 1 door mirrored on both sides, left hinged, with sensor switch, 2 sockets, 2 vertical LED lighting elements (dimnable), without / with ambient light (downward) 600 x 150 x 750 mm

H408401 / H408451



Mirror cabinet, 600 mm, aluminium, 1 door mirrored on both sides, left hinged, without socket, without sensor switch, 2 vertical LED lighting elements (dimnable), without / with ambient light (downward) 600 x 150 x 750 mm

H408421 / H408471



Mirror cabinet, 600 mm, aluminium, 1 door mirrored on both sides, right hinged, with sensor switch, 2 sockets, 2 vertical LED lighting elements (dimnable), without / with ambient light (downward) 600 x 150 x 750 mm

H408402 / H408452



Mirror cabinet, 600 mm, aluminium, 1 door mirrored on both sides, right hinged, without socket, without sensor switch, 2 vertical LED lighting elements (dimnable), without / with ambient light (downward) 600 x 150 x 750 mm

H408422 / H408472



Mirror cabinet, 1200 mm, aluminium, 3 doors mirrored on both sides, with sensor switch, 2 sockets, 4 vertical LED lighting elements (dimnable), without / with ambient light (downward) 1200 x 150 x 750 mm

H408804 / H408854



Mirror cabinet, 1200 mm, aluminium, 3 doors mirrored on both sides, without socket, without sensor switch, 4 vertical LED lighting elements (dimnable), without / with ambient light (downward) 1200 x 150 x 750 mm

H408824 / H408874



Mirror cabinet, 1300 mm, aluminium, 3 doors mirrored on both sides, with sensor switch, 2 sockets, 4 vertical LED lighting elements (dimnable), without / with ambient light (downward) 1300 x 150 x 750 mm

H408704 / H408754



Mirror cabinet, 1300 mm, aluminium, 3 doors mirrored on both sides, without socket, without sensor switch, 4 vertical LED lighting elements (dimnable), without / with ambient light (downward) 1300 x 150 x 750 mm

H408724 / H408774



Mirror with aluminium frame

800 / 900 x 25 x 700 mm

H447404 / H447405



Mirror with aluminium frame

1000 / 1200 x 25 x 700 mm

H447406 / H447407



Mirror with aluminium frame

1300 / 1500 / 1800 x 25 x 700 mm

H447408 / H447409 / H447410



Mirror with aluminium frame, made-to-measure, min./max. 300x150/2200x1200 mm

300-2200 x 25 x 150-1200 mm

H447420



LED light element, horizontal, without / with switch

450 x 25 x 25 mm

H447451 / H447452 / H447461 / H447462



LED light element, horizontal, without / with switch

600 x 25 x 25 mm

H447471 / H447472 / H447481 / H447482



LED light element, horizontal, without / with switch

800 x 25 x 25 mm

H447491 / H447492 / H447501 / H447502



LED light element, horizontal, without / with switch

1000 x 25 x 25 mm

H447511 / H447512 / H447521 / H447522

FRAME 25



LED light element, horizontal,
without / with switch

1300 x 25 x 25 mm

**H447531 / H447532 / H447541 /
H447542 / H447551 / H447552**



LED light element, horizontal,
without / with switch,
made-to-measure, 450-2000 mm
450-2000 x 25 x 25 mm

H447561 / H447562



LED light element, vertical
(for mirror 700 mm in height) /
with switch

700 x 25 x 25 mm

H447571 / H447572



Light, horizontal, 400 / 600 / 800 mm,
matching mirrors with frame black matt

400 / 600 / 800 x 50 x 13 mm

H447563 / H447564 / H447565



Glass shelf, 450 / 550 mm

450 / 550 x 120 x 10 mm

H447580 / H447581



Glass shelf, 600 / 650 mm

600 / 650 x 120 x 10 mm

H447582 / H447583



Glass shelf, 800 / 900 mm

800 / 900 x 120 x 10 mm

H447584 / H447585



Glass shelf, 1000 / 1200 mm

1000 / 1200 x 120 x 10 mm

H447586 / H447587

Colours **Glass shelves (mounting bracket)**

.007
Chromed matt

.450*
Black matt

For more details see separately available technical catalogue

FRAME 25

Colours Lamps



* only for H447563, H447564, H447565



Glass shelf, 1300 / 1500 / 1800 mm

1300 / 1500 / 1800 x 120 x 10 mm

H447588 / H447589 / H447590



Glass shelf, made-to-measure, 300-2200 mm

300-2200 x 120 x 10 mm

H447591



Mounting kit for direct mounting of frame 25 glass shelves onto frame 25 mirror, 2 pieces, aluminium, (for shelves > 1200 mm, 2 sets required)

H490717



Mounting kit for direct mounting of frame 25 glass shelves directly onto frame 25 mirror, 3 pieces, aluminium, (for shelves 650-1200 mm)

H490718

LEELO MIRROR RANGE



LEELO mirror 120 with LED light and touch sensor VAL double washbasin 120 with semi-wet area; single lever basin mixer; towel holder

NEW MIRROR RANGE

The choice of mirror is a detail which is fundamental for the ambiance of the room. With LEELO, we have created a flexible solution which carries the essence of all our product lines and allows itself to be combined with the complete portfolio.

LEELO



LEELO mirror 45 with LED light and touch sensor VAL washbasin 53 with semi-wet area; single lever basin mixer; towel holder



LEELO mirror 60 with LED light and touch sensor



LEELO mirror 80 with LED light and touch sensor
VAL small washbasin round 55; ceramic toilet paper holder



Mirror, 450 mm, with integrated horizontal LED lighting, for room switch / 1 touch sensor (On/ Off/ Dimmer) / ambient light, 3 touch sensors (On-Off/ Dimmer/ Colour temperature change)
450 x 38/32 x 800 mm

H447611 / H447612 / H447613



Mirror, 550 mm with integrated horizontal LED lighting, for room switch / 1 touch sensor (On/ Off/ Dimmer) / ambient light, 3 touch sensors (On-Off/ Dimmer/ Colour temperature change)
550 x 38 x 800 mm

H447621 / H447622 / H447623



Mirror, 600 mm with integrated horizontal LED lighting, for room switch / 1 touch sensor (On/ Off/ Dimmer) / ambient light, 3 touch sensors (On-Off/ Dimmer/ Colour temperature change)
600 x 38 x 700 mm

H447631 / H447632 / H447633



Mirror, 800 mm with integrated horizontal LED lighting, for room switch / 1 touch sensor (On/ Off/ Dimmer) / ambient light, 3 touch sensors (On-Off/ Dimmer/ Colour temperature change)
800 x 38 x 700 mm

H447641 / H447642 / H447643



Mirror, 900 mm with integrated horizontal LED lighting, for room switch / 1 touch sensor (On/ Off/ Dimmer) / ambient light, 3 touch sensors (On-Off/ Dimmer/ Colour temperature change)
900 x 38 x 700 mm

H447651 / H447652 / H447653



Mirror, 1000 mm with integrated horizontal LED lighting, for room switch / 1 touch sensor (On/ Off/ Dimmer) / ambient light, 3 touch sensors (On-Off/ Dimmer/ Colour temperature change)
1000 x 38 x 700 mm

H447661 / H447662 / H447663



Mirror, 1200 mm with integrated horizontal LED lighting, for room switch / 1 touch sensor (On/ Off/ Dimmer) / ambient light, 3 touch sensors (On-Off/ Dimmer/ Colour temperature change)
1200 x 38 x 700 mm

H447671 / H447672 / H447673



Mirror, 1300 mm with integrated horizontal LED lighting, for room switch / 1 touch sensor (On/ Off/ Dimmer) / ambient light, 3 touch sensors (On-Off/ Dimmer/ Colour temperature change)
1300 x 38 x 700 mm

H447681 / H447682 / H447683



Mirror, 1500 mm with integrated horizontal LED lighting, for room switch / 1 touch sensor (On/ Off/ Dimmer) / ambient light, 3 touch sensors (On-Off/ Dimmer/ Colour temperature change)
1500 x 38 x 700 mm

H447691 / H447692 / H447693



Mirror, 1800 mm with integrated horizontal LED lighting, for room switch / 1 touch sensor (On/ Off/ Dimmer) / ambient light, 3 touch sensors (On-Off/ Dimmer/ Colour temperature change)
1800 x 38 x 700 mm

H447701 / H447702 / H447703

SENTEC BATHTUBS



SONAR bathtub, made of Sentec solid surface with wall connection, tap bank and integrated overflow
KARTELL BY LAUFEN 5-hole deck-mounted bath mixer

SENTEC BATHTUBS

The force of nature is unexpectedly conjured up in a solid surface bathtub. With the high proportion of mineral particles, the surface feels as smooth as stone which has been rounded and polished over time by gently flowing water.

The pleasant, warm touch of the surface conveys a feeling of health and cleanliness - providing pure relaxation.



VAL freestanding bathtub KARTELL BY LAUFEN bath mixer



KARTELL BY LAUFEN Bathtub; column bath mixer; combipack washbasin with vanity unit 60; stool ‚Max-Beam‘ FRAME 25 Mirror

SENTEC BATHTUBS



SONAR

Bathtub, made of Sentec solid surface, with wall connection, tap bank and integrated overflow
1600 x 815 mm

H220347



ILBAGNOALESSI ONE

Bathtub, fitted version, with centre outlet, with frame, made of Sentec solid surface
1780 x 820 mm

H245971



ILBAGNOALESSI ONE

Freestanding bathtub, made of Sentec solid surface, with centre outlet, with lifting system
1830 x 870 mm

H245972



PALOMBA COLLECTION

Freestanding bathtub, made of Sentec solid surface

1800 x 890 mm

H245802



KARTELL BY LAUFEN

Freestanding bathtub, made of Sentec solid surface

1715 x 815 mm

H226332



THE NEW CLASSIC

Freestanding bathtub, made of solid surface material Sentec

1900 x 900 mm

H220852



INO

Freestanding bathtub, made of Sentec solid surface

1700 x 750 mm

H231302



INO

Freestanding bathtub, made of Sentec solid surface, with integrated head rest

1800 x 800 mm

H230302

Colours **Bathtubs**



.000
White



Neck cushion, black, self-adhesive, for curved bathtub contours

355 x 190 x 30 mm

H294103

Neck cushion, black, self-adhesive, for straight bathtub contours

312 x 122 x 50 mm

H294680

SENTEC BATHTUBS



KARTELL BY LAUFEN

Bathtub, drop-in version, made of Sentec solid surface, with tap bank on left-hand / right-hand side, with slot overflow in the side at the front, with frame
1700 x 860 mm

H223331 / H224331



KARTELL BY LAUFEN

Bathtub, right / left corner, made of Sentec solid surface, with panel, with tap bank, with slot overflow in the side at the front, with frame
1700 x 860 mm

H223335 / H224336



KARTELL BY LAUFEN

Freestanding bathtub, made of Sentec solid surface, with tap bank on left-hand / right-hand side, with slot overflow, with lifting system
1700 x 860 mm

H224332 / H223332



KARTELL BY LAUFEN

Freestanding bathtub, made of Sentec solid surface, with slot overflow and tap bank at foot end, with lifting system
1760 x 760 mm

H222332



VAL

Freestanding bathtub, made of Sentec solid surface, with integrated overflow and feet

1300 x 1300 mm

H231282



VAL

Freestanding bathtub, made of Sentec solid surface, with integrated overflow and feet

1600 x 750 mm

H230282



Backrest, light grey

400 x 90 x 625 mm

H292340



Tray for Sonar bathtubs

265 x 265 x 80 mm

H293340

ACRYLIC BATHTUBS AND SHOWER TRAYS



PALOMBA COLLECTION freestanding bathtub

ACRYLIC BATHTUBS AND SHOWER TRAYS

As modern bathrooms should reflect the individuality and personality of their users, bathrooms made of sanitary acrylic are available in many different shapes and sizes. They are designed to fit into any bathroom environment and ambiance.

ACRYLIC BATHTUBS AND SHOWER TRAYS



ILBAGNOALESSI ONE

Freestanding bathtub, oval, with panel, with centre outlet, sanitary acrylic

2030 x 1020 mm

H241970



ILBAGNOALESSI ONE

Bathtub, oval, drop-in version, with centre outlet, with frame, sanitary acrylic

2030 x 1020 mm

H243970



ILBAGNOALESSI ONE

Bathtub, oval, semi-recessed, with half panel, with centre outlet, sanitary acrylic

2030 x 1020 mm

H244970



PALOMBA COLLECTION

Freestanding bathtub, with panel and centre outlet, sanitary acrylic

1800 x 900 mm

H231800



LAUFEN PRO

Bathtub for right-hand corner / left-hand corner with panel, sanitary acrylic

1600 x 700 mm

H233955 / H233956



LAUFEN PRO

Bathtub, drop-in version / fitted version, sanitary acrylic

1700 x 700 mm

H230950 / H230951



LAUFEN PRO

Bathtub for right-hand corner / left-hand corner with panel, sanitary acrylic

1700 x 700 mm

H230955 / H230956



LAUFEN PRO

Bathtub, drop-in version / fitted version, sanitary acrylic

1700 x 750 mm

H231950 / H231951



SOLUTIONS

Shower tray, square, made of sanitary acrylic, flat (45 mm)

800 x 800 / 900 x 900 / 1000 x 1000 mm

H211501 / H211502 / H211503



SOLUTIONS

Shower tray, rectangular, made of sanitary acrylic, flat (45 mm)

900 x 750 mm

H211505



SOLUTIONS

Shower tray, rectangular, made of sanitary acrylic, flat (45 mm)

1000 x 800 / 900 mm

H211508 / H211509



SOLUTIONS

Shower tray, rectangular, made of sanitary acrylic, flat (45 mm)

1200 x 800 / 900 mm

H212502 / H212503



SOLUTIONS

Bathtub, drop-in version / fitted version, sanitary acrylic

1700 x 700 mm

H222500 / H222501



SOLUTIONS

Bathtub for right-hand corner / left-hand corner with panel, sanitary acrylic

1700 x 700 mm

H222505 / H222506



SOLUTIONS

Oval bathtub, drop-in version / fitted version, sanitary acrylic

1700 x 750 mm

H222510 / H222511



SOLUTIONS

Oval bathtub, freestanding version, sanitary acrylic

1700 x 750 mm

H222512

For more details see separately available technical catalogue

ACRYLIC BATHTUBS AND SHOWER TRAYS



PALOMBA COLLECTION
Bathtub, drop-in version / fitted version, with centre outlet, rim 40 mm, sanitary acrylic
1800 x 900 mm
H232800 / H232801



PALOMBA COLLECTION
Bathtub, drop-in version / with frame, rim 20 mm, sanitary acrylic
1800 x 800 mm
H242800 / H242801



PALOMBA COLLECTION
Bathtub, drop-in version / with frame, rim 80 mm, sanitary acrylic
1800 x 800 mm
H243800 / H243801



LAUFEN PRO
Bathtub, drop-in version / fitted version, sanitary acrylic
1600 x 700 mm
H233950 / H233951



LAUFEN PRO
Bathtub for right-hand corner / left-hand corner with panel, sanitary acrylic
1700 x 750 mm
H231955 / H231956



LAUFEN PRO
Bathtub with centre outlet, drop-in version / fitted version, sanitary acrylic
1800 x 800 mm
H232950 / H232951



LAUFEN PRO
Bathtub with centre outlet for right-hand corner / left-hand corner with panel, sanitary acrylic
1800 x 800 mm
H232955 / H232956



LAUFEN PRO
Bathtub with centre outlet, drop-in version / fitted version, sanitary acrylic
1900 x 900 mm
H234950 / H234951



SOLUTIONS
Shower tray, rectangular, made of sanitary acrylic, flat (45 mm)
1400 x 800 / 900 mm
H212507 / H212508



SOLUTIONS
Shower tray, rectangular, made of sanitary acrylic, flat (45 mm)
1600 x 900 / 1700 x 800 / 1800 x 900 mm
H214508 / H215507 / H216508



SOLUTIONS
Quadrant shower tray, made of sanitary acrylic, flat (45 mm)
900 x 900 / 1000 x 1000 mm
H213502 / H213503



SOLUTIONS
Shower tray, pentagonal, made of sanitary acrylic, flat (45 mm)
900 x 900 mm
H214502



SOLUTIONS
Bathtub, drop-in version / fitted version, sanitary acrylic
1700 x 750 mm
H223500 / H223501



SOLUTIONS
Bathtub for right-hand corner / left-hand corner with panel, sanitary acrylic
1750 x 750 mm
H223505 / H223506



SOLUTIONS
Space-saving bathtub, drop-in version / fitted version, sanitary acrylic
1700 x 750 mm
H223510 / H223511



SOLUTIONS
Space-saving bathtub, drop-in version / fitted version, sanitary acrylic
1700 x 750 mm
H223520 / H223521

For more details see separately available technical catalogue

ACRYLIC BATHTUBS AND SHOWER TRAYS



SOLUTIONS

Bathtub with centre outlet, drop-in version / fitted version, sanitary acrylic

1700 x 750 mm

H223530 / H223531



SOLUTIONS

Bathtub with centre outlet, for right-hand corner / left-hand corner with panel, sanitary acrylic

1700 x 750 mm

H223535 / H223536



SOLUTIONS

Bathtub, drop-in version / fitted version, sanitary acrylic

1800 x 800 mm

H224500 / H224501



SOLUTIONS

Bathtub with centre outlet, for right-hand corner / left-hand corner with panel, sanitary acrylic

1800 x 800 mm

H224505 / H224506



SOLUTIONS

Hexagonal bathtub, drop-in version / fitted version, sanitary acrylic

1900 x 900 mm

H225520 / H225521



SOLUTIONS

Bathtub, corner model, drop-in version / fitted version / with front panel, sanitary acrylic

1400 x 1400 mm

H242500 / H242501 / H242507



SOLUTIONS

Bathtub, corner model, drop-in version / fitted version / with front panel, sanitary acrylic

1500 x 1500 mm

H244500 / H244501 / H244507



Neck cushion, black, self-adhesive, for curved bathtub contours

355 x 190 x 30 mm

H294103

ACRYLIC BATHTUBS AND SHOWER TRAYS



SOLUTIONS
Oval bathtub, drop-in version / fitted version, sanitary acrylic

1800 x 800 mm

H224510 / H224511



SOLUTIONS
Oval bathtub, freestanding version, sanitary acrylic

1800 x 800 mm

H224512



SOLUTIONS
Oval bathtub, drop-in version / fitted version, sanitary acrylic

1900 x 900 mm

H225510 / H225511



SOLUTIONS
Oval bathtub, freestanding version, sanitary acrylic

1900 x 900 mm

H225512

Colours **Bathtubs and shower trays**



.000

White



Neck cushion, black, self-adhesive, for straight bathtub contours

312 x 122 x 50 mm

H294680

STEEL BATHTUBS AND SHOWER TRAYS

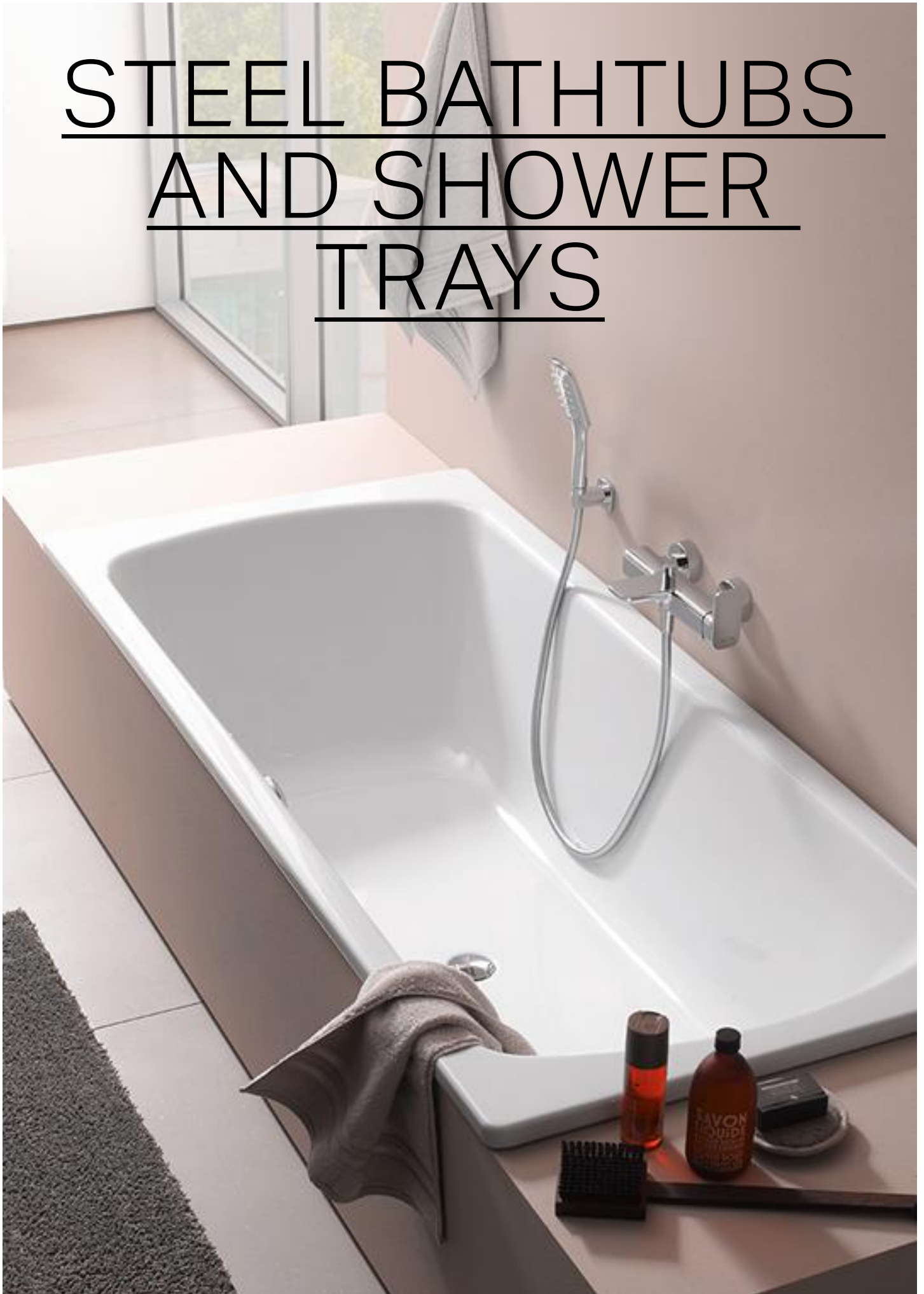

LAUFEN PRO steel bathtub

STEEL BATHTUBS AND SHOWER TRAYS

There are not many things that will last a lifetime. With bathtubs and shower trays made of heavy-duty, enamelled steel, LAUFEN however creates a pleasant feeling of eternity. The products present themselves in their most beautiful designs as being dimensionally stable, scratch, impact, and abrasion-resistant.



INDURA steel shower tray



PLATINA steel shower tray

STEEL BATHTUBS AND SHOWER TRAYS



LAUFEN PRO
Bathtub, drop-in version, enamelled steel (3 mm) / with holes for handles pre-drilled
1500 x 700 mm
H221950 / H221953



LAUFEN PRO
Bathtub, drop-in version, enamelled steel (3 mm) / with holes for handles pre-drilled
1500 x 750 mm
H222950 / H222953



LAUFEN PRO
Bathtub, drop-in version, enamelled steel (3.5 mm) / with holes for handles pre-drilled
1600 x 700 mm
H223950 / H223953



LAUFEN PRO
Bathtub, drop-in version, enamelled steel (3.5 mm) / with holes for handles pre-drilled
1700 x 700 mm
H224950 / H224953



PALLADIUM
Bathtub, drop-in version, enamelled steel (3.5 mm) / with holes for handles pre-drilled
1700 x 750 mm
H225110 / H225113



THALLIUM
Bathtub, drop-in version, with centre outlet, enamelled steel 3 mm
1800 x 800 mm
H225090



THALLIUM
Bathtub, oval, drop-in version, with centre outlet, enamelled steel 3 mm
1800 x 800 mm
H225080

Colours **Bathtubs**

	.000 White
	.600 White with antislip



INDURA
Shower tray, rectangular, enamelled steel (3.5 mm), extra flat (25 mm)
1000 / 1200 / 1400 x 800 mm
H215073 / H215074 / H215076



INDURA
Shower tray, rectangular, enamelled steel (3.5 mm), extra flat (25 mm)
1400 x 700 mm
H215075



PLATINA
Shower tray, square, enamelled steel (3.5 mm), extra flat (25 mm)
800 x 800 / 900 x 900 / 1000 x 1000 mm
H215001 / H215002 / H215004



PLATINA
Shower tray, rectangular, enamelled steel (3.5 mm), extra flat (25 mm)
900 x 750 mm
H215003



PLATINA
Shower tray, square, enamelled steel (3.5 mm), flat (65 mm)
800 x 800 / 900 x 900 / 1000 x 1000 mm
H215011 / H215012 / H215014



PLATINA
Shower tray, rectangular, enamelled steel (3.5 mm), flat (65 mm)
900 x 750 mm
H215013



PLATINA
Shower tray, rectangular, enamelled steel (3.5 mm), flat (65 mm)
1000 / 1200 / 1400 x 800 mm
H215041 / H215015 / H215016



PLATINA
Shower tray, rectangular, enamelled steel (3.5 mm), flat (65 mm)
1000 / 1200 / 1400 x 900 mm
H215031 / H215033 / H215035

For more details see separately available technical catalogue

STEEL BATHTUBS AND SHOWER TRAYS



LAUFEN PRO
Bathtub, drop-in version, enamelled steel (3.5 mm) / with holes for handles pre-drilled
1700 x 750 mm
H225950 / H222953



LAUFEN PRO
Bathtub with centre outlet, drop-in version, enamelled steel (3.5 mm) / with holes for handles pre-drilled
1700 x 750 mm
H226950 / H226952



LAUFEN PRO
Bathtub with centre outlet, drop-in version, enamelled steel (3.5 mm) / with holes for handles pre-drilled
1800 x 800 mm
H227950 / H227952



PALLADIUM
Bathtub, drop-in version, enamelled steel (3.5 mm) / with holes for handles pre-drilled
1800 x 800 mm
H225100 / H225103



Neck cushion, black, self-adhesive, for straight bathtub contours
312 x 122 x 50 mm
H294680

LAUFEN PRO/PALLADIUM
Handles for steel bathtubs, chromed
H296181

PALLADIUM
Feet for bathtub, height-adjustable 13.5-19 cm
mm
H296171



INDURA
Shower tray, square, enamelled steel (3.5 mm), extra flat (25 mm)
900 x 900 / 1000 x 1000 mm
H215071 / H215072



PLATINA
Shower tray, rectangular, enamelled steel (3.5 mm), extra flat (25 mm)
1000 / 1200 / 1400 x 800 mm
H215040 / H215005 / H215006



PLATINA
Shower tray, rectangular, enamelled steel (3.5 mm), extra flat (25 mm)
1000 / 1200 / 1400 x 900 mm
H215030 / H215032 / H215034



PLATINA
Shower tray, rectangular, enamelled steel (3.5 mm), flat (45 mm)
1600 / 1800 x 900 mm
H215036 / H215037



PLATINA
Quadrant shower tray, enamelled steel (3.5 mm), radius 550 mm, extra flat (25 mm)
900 x 900 / 1000 x 1000 mm
H215008 / H215009



PLATINA
Quadrant shower tray, enamelled steel (3.5 mm), radius 550 mm, flat (65 mm)
900 x 900 / 1000 x 1000 mm
H215018 / H215019



PLATINA
Shower tray, square, enamelled steel (3.5 mm), deep (150 mm)
800 x 800 / 900 x 900 mm
H215021 / H215022



PLATINA
Shower tray, rectangular, enamelled steel (3.5 mm), deep (150 mm)
900 x 750 mm
H215023

Colours Shower trays INDURA

	.000 White
	.076 Anthracite
	.657 White matt with antislip
	.676 Anthracite with antislip
	.757 White matt

Colours Shower trays PLATINA

	.000 White
	.600 White with antislip

CERAMIC SHOWER TRAYS



MERANO ceramic shower tray, square

CERAMIC SHOWER TRAYS

There are many good reasons to choose a shower tray made of sanitary ceramics. Characterised by their long life and tangible quality, they are also very hygienic and resistant against fungi and bacteria due to their glazing. Each and every one is beautifully made to look great in any bathroom.



MERANO
Shower tray, square, sanitary ceramic,
flat (45 mm)

800 x 800 / 900 x 900 mm

H852951 / H853951



MERANO
Shower tray, rectangular, sanitary
ceramic, flat (45 mm)

1200 x 700/800 mm

H854954 / H854953



MERANO
Quadrant shower tray, sanitary cera-
mic, flat (45 mm)

800 x 800 / 900 x 900 mm

H852953 / H853953

Colours **Shower trays**



MARBOND BATHTUBS AND SHOWER TRAYS



LAUFEN SOLUTIONS Rectangular shower tray, square 90

MARBOND BATHTUBS AND SHOWER TRAYS

Marbond is a robust composite material from LAUFEN, made of two layers with a high-strength bond between them. It is based on a high quality solid surface material with a robust gel coat finish.

Marbond offers following advantages:

- Pleasant, natural feel
- Surface is easy to clean and care for
- The smooth, anti-bacterial surface hardly attracts any dirt
- Available in colours White and Sand (Solutions Marbond shower trays)
- optional cut-to-size (Solutions Marbond shower trays)
- UV and chemical-resistant according to DIN EN 14527
- Thermal shock resistant according to DIN EN 14527
- Anti-slip surface =
high slip security (DIN 51097, Class C for Solutions Marbond shower trays)
- In the case of damage - e.g. scratches etc. - a repair set is available
- Noise protection standards SIA 181 and DIN 4109 certified



LAUFEN SOLUTIONS Shower tray



LAUFEN PRO Freestanding bathtub



















LAUFEN SOLUTIONS Shower tray, square 90

SOLUTIONS



LAUFEN SOLUTIONS shower tray, square CITY PRO thermostatic showerstation, rain shower head

INSTALLATION ACCESSORIES FOR LAUFEN SOLUTIONS (MARBOND)

Type of installation / accessories	Installation frame 298441 / 298442	Drain set for shower tray 295127	Bath sealing strip 295642	3D sealing corner inside 295643	Outside corner set 295644	Dispersion sealing mass 295645	Additional sealing tape if shower tray circumference >3 m 295647	Bathtub profile, only once floor and wall are completely finished 295551
								
L-installation, corner left / right								
 Level with floor	■	■	■	in sealing set	■	2x 500 ml	2x 2 m	
 Semi-recessed	■	■	■	in sealing set	■	2x 500 ml	2x 2 m	
 Surface-mounted <i>Poser au sol</i>	■	■						■
Walk-in, wall-linked								
 Level with floor	■	■	■		2 x ■	2x 500 ml	2x 2 m	
 Semi-recessed	■	■	■		2 x ■	2x 500 ml	2x 2 m	
 Surface-mounted	■	■						■
U-installation / alcove								
 Level with floor	■	■	■	■	■	2x 500 ml	2x 2 m	
 Semi-recessed	■	■	■	■	■	2x 500 ml	2x 2 m	
 Surface-mounted	■	■						■

MARBOND BATHTUBS AND SHOWER TRAYS



SONAR
Freestanding bathtub with tap bank and surface structure, made of Marbond composite material
1600 x 815 mm
H221342



LAUFEN PRO
Bathtub, rectangular, made of Marbond composite material, drop-in version
1700 x 750 / 1800 x 800 mm
H242950 / H240950



LAUFEN PRO
Bathtub, drop-in version, oval, made of Marbond composite material
1800 x 800 mm
H241950



LAUFEN PRO
Freestanding bathtub, made of Marbond composite material
1500 x 700 / 1650 x 750 mm
H243952 / H239952



LAUFEN PRO
Shower tray, made of Marbond composite material, super flat, square, outlet at side
800 x 800 / 900 x 900 mm
H210950 / H210956



LAUFEN PRO
Shower tray, made of Marbond composite material, super flat, square, outlet at side
1000 x 1000 / 1200 x 1200 mm
H211952 / H211958



LAUFEN PRO
Shower tray, made of Marbond composite material, super flat, rectangular, outlet at long side
900 x 800 mm
H214950



LAUFEN PRO
Shower tray, made of Marbond composite material, super flat, rectangular, outlet at short side
1000 x 800 / 900 mm
H210951 / H210957



LAUFEN PRO
Shower tray, made of Marbond composite material, super flat, square, outlet at side
1400 x 1400 mm
H212958



LAUFEN PRO
Shower tray, made of Marbond composite material, super flat, rectangular, outlet at short side
1500 x 700 / 800 / 900 mm
H212959 / H213951 / H213952



LAUFEN PRO
Shower tray, made of Marbond composite material, super flat, square, outlet at side
1500 x 1500 mm
H213953



LAUFEN PRO
Shower tray, made of Marbond composite material, super flat, rectangular, outlet at short side
1600 x 700 / 750 / 800 / 900 mm
H213954 / H213955 / H213958 / H213959



LAUFEN PRO
Shower tray, made of Marbond composite material, super flat, rectangular, outlet at long side
1600 x 700 / 750 mm
H213956 / H213957



LAUFEN PRO
Shower tray, made of Marbond composite material, super flat, rectangular, outlet at long side
1600 x 800 / 900 / 1000 mm
H210954 / H211950 / H211955



LAUFEN PRO
Shower tray, made of Marbond composite material, super flat, rectangular, outlet at long side
1800 x 700 / 750 mm
H214956 / H214958



LAUFEN PRO
Shower tray, made of Marbond composite material, super flat, rectangular, outlet at long side
1800 x 800 / 900 / 1000 mm
H210955 / H211951 / H211956

For more details see separately available technical catalogue

MARBOND BATHTUBS AND SHOWER TRAYS

Colours **Bathtubs SONAR + LAUFEN PRO**



LAUFEN PRO
Bathtub, corner version right/left, incl. feet for bathtub, made of Marbond composite material
1800 x 800 mm
H244955 / H244956



Backrest, light grey
400 x 90 x 625 mm
H292340



Tray for Sonar bathtubs
265 x 265 x 80 mm
H293340



LAUFEN PRO
Shower tray, made of Marbond composite material, super flat, rectangular, outlet at short side
1100 x 800 / 900 mm
H212954 / H212955



LAUFEN PRO
Shower tray, made of Marbond composite material, super flat, rectangular, outlet at short side
1200 x 700 / 800 / 900 / 1000 mm
H212951 / H210952 / H210958 / H211953



LAUFEN PRO
Shower tray, made of Marbond composite material, super flat, rectangular, outlet at short side
1300 x 700 mm
H212952



LAUFEN PRO
Shower tray, made of Marbond composite material, super flat, rectangular, outlet at short side
1400 x 700 / 800 / 900 mm
H212953 / H212956 / H212957



LAUFEN PRO
Shower tray, made of Marbond composite material, super flat, rectangular, outlet at short side
1700 x 750 / 800 mm
H214951 / H214953



LAUFEN PRO
Shower tray, made of Marbond composite material, super flat, rectangular, outlet at short side
1800 x 750 / 800 mm
H214959 / H211959



LAUFEN PRO
Shower tray, made of Marbond composite material, super flat, rectangular, outlet at long side
1400 x 700 / 800 mm
H215954 / H210953



LAUFEN PRO
Shower tray, made of Marbond composite material, super flat, rectangular, outlet at long side
1400 x 900 / 1000 mm
H210959 / H211954

Colours **Shower trays LAUFEN PRO**

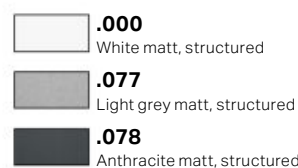

LAUFEN PRO
Shower tray, made of Marbond composite material, super flat, rectangular, outlet at long side
2000 x 900 / 1000 mm
H215953 / H211957



LAUFEN PRO
Shower tray, made of Marbond composite material, super flat, made-to-measure
750 - 2000 x 700 - 1000 mm
H212950

Colours **Shower trays**



For more details see separately available technical catalogue

MARBOND BATHTUBS AND SHOWER TRAYS



SOLUTIONS

Shower tray, made of Marbond composite material, super flat, square, outlet at side

800 x 800 / 900 x 900 / 1000 x 1000 mm

H213440 / H215442 / H216441



SOLUTIONS

Shower tray, made of Marbond composite material, super flat, rectangular, centre outlet

1400 x 800 / 900 mm

H213444 / H215445



SOLUTIONS

Shower tray, made of Marbond composite material, super flat, rectangular, centre outlet

1600 x 800 / 900 mm

H213446 / H215446



SOLUTIONS

Shower tray, made of Marbond composite material, super flat, rectangular, outlet at short side

1000 x 700 / 800 / 900 mm

H213441 / H213442 / H215443



SOLUTIONS

Shower tray, made of Marbond composite material, super flat, rectangular, outlet at short side

1800 x 800 / 900 / 1000 mm

H214441 / H214442 / H214443



SOLUTIONS

Shower tray, made of Marbond composite material, super flat, rectangular, outlet at short side

2000 x 900 / 1000 mm

H214444 / H214445



SOLUTIONS

Shower tray, made of Marbond composite material, super flat, rectangular, outlet at short side

2150 x 900 / 1000 mm

H214446 / H216443



SOLUTIONS

Shower tray, made of Marbond composite material, super flat, made-to-measure

H216440



Mounting box left / right for Marbond shower trays type DN 40 with height 75 / mm DN 50 with height 100 mm, siphon not included

460 x 320 x 75 / 100 mm

H290031 / H290032 / H290041 / H290042



Mounting box left / right for Marbond shower trays type DN 40 with height 75 / mm DN 50 with height 100 mm, siphon included

460 x 320 x 75 / 100 mm

H290033 / H290034 / H290043 / H290044

MARBOND BATHTUBS AND SHOWER TRAYS



SOLUTIONS

Shower tray, made of Marbond composite material, super flat, rectangular, outlet at short side

1200 x 700 / 800 / 900 / 1000 mm

H213443 / H215441 / H215444 / H216442



SOLUTIONS

Shower tray, made of Marbond composite material, super flat, rectangular, outlet at short side

1400 x 1000 mm

H213445



SOLUTIONS

Shower tray, made of Marbond composite material, super flat, rectangular, outlet at short side

1600 x 1000 mm

H213447



SOLUTIONS

Shower tray, made of Marbond composite material, super flat, rectangular, outlet at short side

1700 x 750 / 800 / 900 mm

H213448 / H213449 / H214440

Colours **Shower trays SOLUTIONS**



.000

White matt



.035

Sand

PUBLIC URINALS



CAPRINO PLUS urinal RION urinal partition

UNLIMITED POSSIBILITIES

With PUBLIC urinals, design, comfort and hygiene are combined to a single unit, which has virtually no limits to where it can be installed. Whether it be in the catering sector (restaurants, bars and hotels), stations and airports, businesses, public buildings such as schools and congress centres, or shopping centres, cinemas, theatres or concert halls – these urinals, most of which are equipped with electronic flushing, can be used virtually anywhere.



LEMA urinal

ANTERO Design by Toan Nguyen



ANTERO Urinal

An eco-friendly urinal for prestigious washroom facilities: With its Antero urinal LAUFEN offers outstanding design and meticulously well-conceived functions to create prestigious washroom facilities for guests, customers and staff. This skillful combination of the two qualities, form and function in product design, has earned the urinal the Red Dot Award 2012 as well as a Special Mention from the German Design Award in 2014. The outstanding design has been developed by Toan Nguyen.



reddot design award
winner 2012



German
Design Award
SPECIAL
MENTION 2014

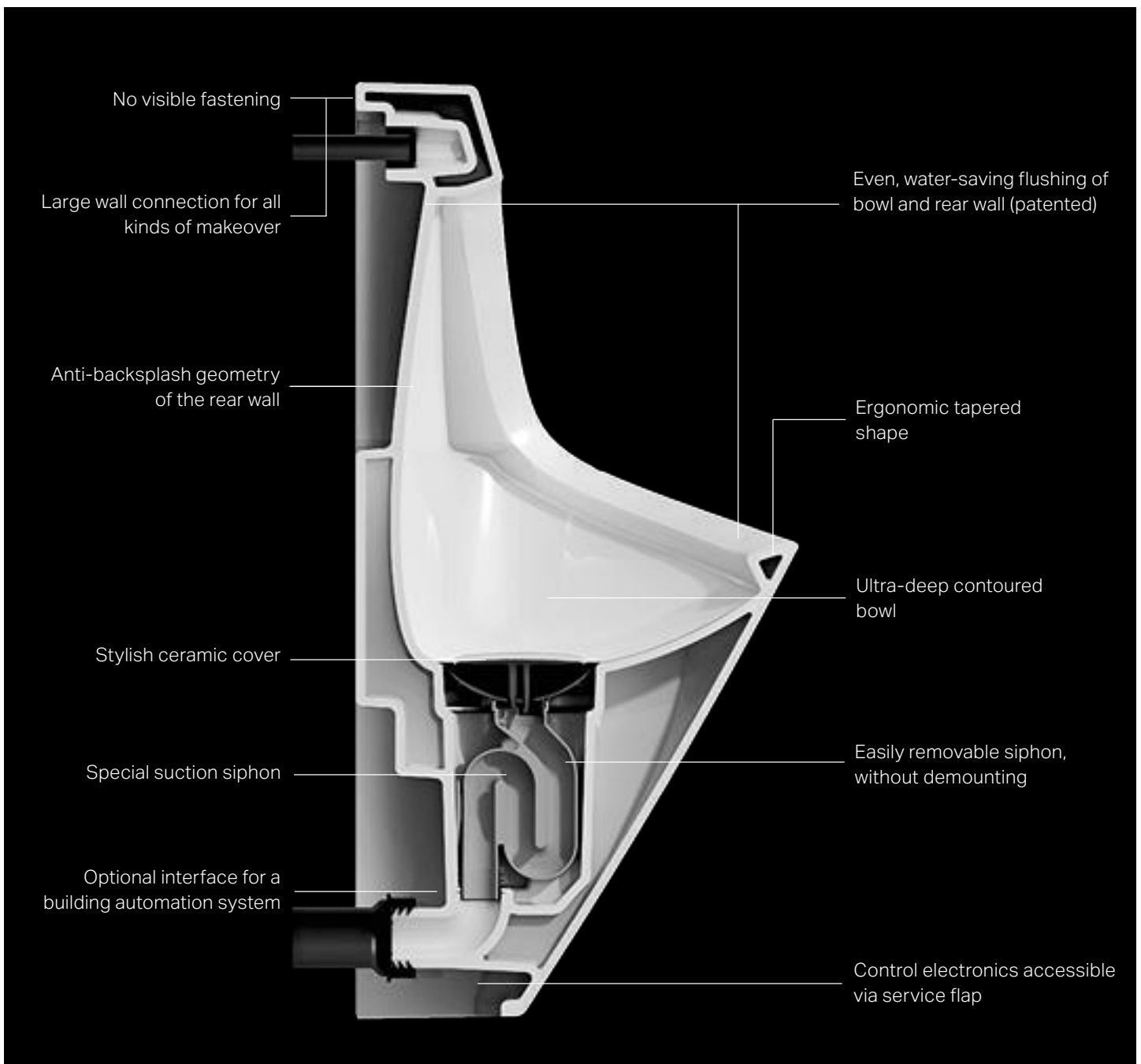

LAUFEN urinals are revolutionising the upkeep and maintenance of public sanitary facilities. Up till now, urinals often had to be completely disassembled when replacing their siphons. ANTERO and LEMA allow you to release and pull the siphon out easily using a special key.

The siphon on ANTERO und LEMA urinals can be changed easily, quickly and economically:

1. Remove ceramic cover by hand.
2. Lift siphon up and out using special key.
3. Clean urinal and rinse pipes.
4. Insert the new siphon.
5. Place ceramic cover.



URINALE PUBLIC



ANTERO

Siphonic urinal, internal water inlet, with flushing rim, with electronic control, battery operated (9V) / mains operated (230V) incl. Bluetooth module
380 x 365 x 770 mm

H841150 / H841152



ANTERO

Siphonic urinal, internal water inlet, with flushing rim

380 x 365 x 770 mm

H841153



ANTERO

Siphonic urinal, internal water inlet, with electronic control, mains operated (230V) / battery operated (9V)

380 x 365 x 770 mm

H840152 / H840150



ANTERO

Siphonic urinal, internal water inlet

380 x 365 x 770 mm

H840153



LEMA

Siphonic urinal, internal water inlet, with electronic control, battery operated (6V) / mains operated (230V)

350 x 400 x 700 mm

H840194 / H840196



LEMA

Siphonic urinal, internal water inlet

350 x 400 x 700 mm

H840197



LEMA

Siphonic urinal, internal water inlet, with electronic control, mains operated (230V), concealed power supply

350 x 400 x 700 mm

H840198



LEMA

Siphonic urinal, internal water inlet, with electronic control, mains operated (230V) with Bluetooth module

350 x 400 x 700 mm

H840199



CAPRINO PLUS

Siphonic urinal, internal water inlet, with electronic control, mains operated (230V) / battery operated (6V)

320 x 350 x 645 mm

H842065 / H842066



TAMARO

Siphonic urinal, internal water inlet

395 x 360 x 770 mm

H840090



TAMARO

Siphonic urinal, internal water inlet, with electronic control, mains operated (230V) / battery operated (6V)

395 x 360 x 770 mm

H840103 / H840104



TARO

Siphonic urinal, rear water inlet horizontal / external water inlet vertical

390 x 390 x 745 mm

H840000 / H840005

URINALE PUBLIC



ANTERO

Siphonic urinal, internal water inlet, with electronic control, mains operated (230V) with Bluetooth module
380 x 365 x 770 mm

H840159



LEMA

Siphonic urinal ,rimless', internal water inlet, with electronic control, battery operated (9V) incl. Bluetooth / mains operated (230V) incl. Bluetooth
350 x 420 x 730 mm

H841190 / H841192



LEMA

Siphonic urinal ,rimless', internal water inlet

350 x 420 x 730 mm

H841193



LEMA

Waterless urinal

350 x 420 x 730 mm

H843197



LEMA

Waterless urinal

350 x 400 x 700 mm

H843195



VAL

Siphonic urinal ,rimless', internal water inlet, without mounting holes for cover, with electronic control system, battery operated (9V), with integrated bluetooth, vandalproof
305 x 365 x 560 mm

H840286 / H840284



VAL

Siphonic urinal ,rimless', internal water inlet, without mounting holes for cover

305 x 365 x 560 mm

H840285



CAPRINO PLUS

Siphonic urinal, internal water inlet / external water inlet vertical

320 x 350 x 645 mm

H842061 / H842062



CINTO

Ceramic urinal divider

400 x 90 x 720 mm

H847603



RION

Ceramic urinal divider

400 x 90 x 720 mm

H847600



VAL

Ceramic urinal divider

370 x 75 x 680 mm

H847280

ANTERO & LEMA CONTROL SYSTEM

ANTRO and LEMA urinals offer everything required by operators of public toilets: A thorough water-saving flush, easy cleaning and maintenance and demand oriented control electronics. The intelligent control system has different modes and can trigger cleaning after each user or at defined intervals with different flush quantities of between 0.5 and 3 litres. Following long periods of non-use, a hygiene flush takes place every 24 hours by default. An integrated overflow protection provides additional safety in the event of the outlet being clogged.



Stadium mode

If usage frequency is high, the system automatically switches to stadium mode, which causes flushing to take place independent of usage. The system then triggers a flush at a programmable interval. If the system detects no usage within a flushing interval, it automatically switches back to normal mode.



Hybrid mode

The urinal flushes at a predefined interval if usage is detected, and not after every single use. The flushing interval can be set to six different values between 1h and 12h. A predefined flushing volume is assigned to each flushing interval.



Bluetooth mode

Bluetooth and a free smart phone app can be used to set the urinal functions from a mobile phone or to monitor statistics and to check its functionality.



USB module

In addition to user-friendly operation via a control panel, settings can be changed conveniently on a laptop using a USB connection. The clear interface of the control software also allows status functions and statistics to be queried.

GLT module

With the help of an additional module, the LAUFEN control system has an interface to popular building control systems. This allows central flushing to be triggered and stopped, the flush quantity to be changed, and status queries to be made.

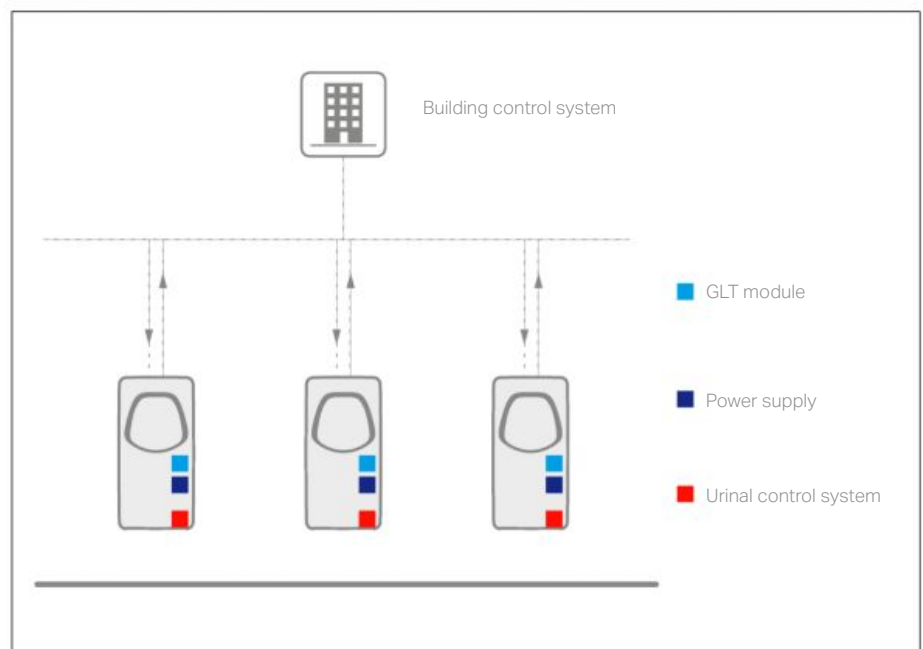

HOME URINALS



VILA urinal PALOMBA bowl washbasin; vanity unit; medium cabinet

For more details see separately available technical catalogue

COMPLICATED IS EASY

Easy is complicated. Intentionally dispensing with the superfluous, combined with superior functionality and logical design, makes the home urinal an extremely intelligent product. Its quality lies in its clarity, which has a decisive influence on how we experience our time in the bathroom. A clear, relaxed atmosphere is by far the best.



ILBAGNOALESSI ONE

Siphonic urinal, internal water inlet, version for cover

325 x 290 x 585 mm

H840971



ILBAGNOALESSI ONE

Siphonic urinal, internal water inlet, version without cover

290 x 325 x 585 mm

H840975



ILBAGNOALESSI ONE

Cover for urinal

H894971



VAL

Siphonic urinal ,rimless', internal water inlet, with mounting holes for cover

305 x 365 x 560 mm

H840281



VAL

Siphonic urinal ,rimless', internal water inlet, without mounting holes for cover

305 x 365 x 560 mm

H840285



VAL

Cover for urinal with lowering system

H894282



CASA

Siphonic urinal, internal water inlet, version for cover

305 x 285 x 465 mm

H840141



CASA

Siphonic urinal, internal water inlet, version without cover

305 x 285 x 465 mm

H840145



CASA

Cover for urinal

H894141



VILA

Siphonic urinal, internal water inlet, version for cover

310 x 280 x 490 mm

H841141



VILA

Siphonic urinal, internal water inlet, version without cover

310 x 280 x 490 mm

H841142



VILA

Cover for urinal with lowering system

H894142

LIS LAUFEN INSTALLATION SYSTEM FOR URINALS

LAUFEN not only does things differently, but takes them forward substantially. With the intelligent installation system LIS, the manufacturer makes it possible to realise a range of different installation scenarios. It's the solution when it comes to installing urinals quickly, safely and smartly. The range includes various surface mounting elements for dry-wall and brick-wall installation. These are also available with pre-assembled LAUFEN urinal control box without integrated control. The network version of the control box already contains a Bluetooth module for the maintenance and servicing of the basic settings via smart control app(iOS & Android).





LAUFEN FAUCETS

FAUCETS

LAUFEN stands for Quality & Design



DESIGN AND DEVELOPMENT

The company provides complete solutions for bathrooms right around the world.



TOOL-MAKING SHOP

Expertise in faucets – since 1854

Very aware of the power and significance of water as an element, LAUFEN is committed to true aesthetic beauty: We give water a shape to enable it to pamper body and soul.



CASTING SHOP

In 2007, ROCA acquired the oldest faucet factory in Switzerland – Similor AG – and since then has been a subsidiary of LAUFEN. This has enabled the company to complete its product range as a complete bathroom provider. For the last 160 years, the employees have drawn their inspiration from the element of water, and their endless stream of innovations turn bathroom faucets into an artwork form.



MACHINING (CHIP-CUTTING) SHOP

From hot ideas to cool faucets

GRINDING SHOP AND POLISHING SHOP



What takes place during the concept and planning phases, and what often heats heads to steaming point, gains its ultimate expression at temperatures approaching 1000 degrees Celsius. Production is now in progress, launching the history of a new faucet. Beholding beauty at all times, we accompany it from station to station, until it achieves its ultimate form.



SURFACE TREATMENT SHOP



FUNCTION TESTS

And at the place where ultra-modern machines reach the limits of their capabilities, that's where we encounter art once again: in the faucet finishing shop. Because pure craftsmanship is what people want.



FINAL ASSEMBLY AND PACKAGING



VAL basin mixer

THE NEW CLASSIC

Faucets

Design by
Marcel Wanders



THE NEW CLASSIC single lever basin mixer; small washbasin 50, undersurface ground; ceramic soap dish and mirror with LED ambient light

NEW FAUCETS

Maximum functionality and a playful approach with distinctive lines. The proportions of these faucets are perfectly integrated in line for an unobtrusive yet exciting manner. A well-balanced whole comes into being which creates the feeling of tranquility you expect from a modern bathroom. Wanders' all-embracing artistic concept of The New Classic sets its sights on consummate aesthetics in the bathroom – and this presupposes the artistic interaction of the interior.



reddot design award
winner 2019



THE NEW CLASSIC bowl washbasin 55, ceramic mirror with LED ambiente light; column single lever basin mixer

THE NEW CLASSIC



THE NEW CLASSIC concealed basin mixer; vanity washbasin 80 with vanity unit; ceramic tooth brush holder and mirror with LED ambient light



THE NEW CLASSIC column single lever basin mixer; bowl washbasin 55



THE NEW CLASSIC wall-mounted single lever bath mixer and spout



THE NEW CLASSIC 3-hole basin mixer

THE NEW CLASSIC FAUCETS



Single lever basin mixer, projection 105 mm, fixed spout, with / without pop-up waste

**H3118510041111 /
H3118510041101**



Single lever basin mixer, projection 130 mm, fixed spout, with / without pop-up waste

**H3118510041211 /
H3118510041201**



Column single lever basin mixer, projection 175 mm, fixed spout, without pop-up waste

H3118580041201



Single lever bidet mixer, projection 110 mm, fixed spout, with pop-up waste

H3418510041111



Wall-mounted single lever bath mixer, with diverter, with / without accessories

**H3218570041411 /
H3218570044001**



Set for concealed single lever shower mixer, with one outlet

H3318560040001



Set for concealed single lever bath mixer, with diverter / with integrated vacuum breaker

**H3218560040001 /
H3218560040101**



Wall-mounted spout, fixed spout, projection 180 mm

H3718500040601

THE NEW CLASSIC FAUCETS



3-hole basin mixer, projection 130 mm, fixed spout, with / without pop-up waste lever, with pop-up waste

**H3128530041211 /
H3128530041201**



Twin handled concealed basin mixer, projection 180 mm

H3128560041201



Concealed single lever basin mixer for Simibox 2-Point, fixed spout, projection 180 mm

H3118560041201



Wall-mounted single lever shower mixer, with one outlet, with / without accessories

**H3318570041411 /
H3318570044001**

Colours **Faucets**

.004
Chromed



Shower hose connector with integrated shower holder, with vacuum breaker, all-metal

H3638500041521



Shower hose connector, with check-valve, all-metal

H3638500041511



Fixed shower holder, all-metal

H3698500042011

Matching concealed systems can be found in the SIMIBOX & ROUGH-IN SETS chapter.
Additional hand showers, shower systems and accessories can be found in the SHOWER ACCESSORIES chapter.

Kartell by LAUFEN



KARTELL BY LAUFEN washbasin, shelf left 60; washbasin shelf right 120; basin mixer; shelf for washbasin; 'Max Beam' stool BOUTIQUE drawer elements



KARTELL BY LAUFEN washbasin with 3-hole basin mixer



KARTELL BY LAUFEN bowl washbasin with column basin mixer

INNOVATIVE AND RICH IN EMOTIONS

An architectural project that speaks a new language. Kartell by LAUFEN is the synthesis of the work which Ludovica + Roberto Palomba have created in recent years in the world of bathrooms and represents an important progress in this area.



KARTELL BY LAUFEN shower mixer with assembly kit for concealed shower mixer Simibox



KARTELL BY LAUFEN column bath mixer

KARTELL BY LAUFEN FAUCETS



Single lever basin mixer ,disc' projection 110 mm, with / without pop-up waste / with pop-up waste lever, without pop-up waste, including storage tray ,disc', transparent crystal

H3113310041111 / H3113310041101 / H3113310041131



Column single lever basin mixer ,disc', projection 110 mm, without pop-up waste, with storage tray ,disc', transparent crystal

H3113380041101



Single lever concealed basin mixer ,disc' for Simibox 1-Point, projection 186 mm, fixed spout, with storage tray ,disc', transparent crystal

H3113370041201



Single lever bidet mixer ,disc', fixed spout, with pop-up waste, with storage tray ,disc', transparent crystal

H3413310041111



Single lever basin mixer, projection 135 mm, fixed spout, with / without pop-up waste

H311331xxx1211 / H311331xxx1201



Column single lever basin mixer, projection 125 mm, fixed spout, without pop-up waste

H311338xxx1201



2-hole basin mixer, projection 166 mm, swivel spout, with / without pop-up waste valve

H3113320042211 / H311332xxx2201



3-hole basin mixer, projection 166 mm, swivel spout, with / without pop-up waste valve

H3123330042211 / H312333xxx2201



Set for concealed single lever bath mixer, with diverter / with integrated vacuum breaker

H321336xxx0001 / H321336xxx0101



Set for concealed shower mixer

H331336xxx0001



Wall-mounted spout, projection 175 mm

H371330xxx0601



5-hole deck-mounted bath mixer, projection 173 mm, without mounting plate

H3223350042821



Extension ring ,twin' 15 mm, matches round set

15 mm

H3799840040501



Extension ring ,twin' 30 mm, matches round set

30 mm

H3799840040601

For more details see separately available technical catalogue

KARTELL BY LAUFEN FAUCETS



Single lever concealed bath mixer ,disc' for Simibox 1-Point, with accessories, with storage tray ,disc', transparent crystal

H3213390041411



Single lever concealed shower mixer ,disc' for Simibox 1-Point, with accessories, with storage tray ,disc', transparent crystal

H3313390041411



Column single lever bath mixer ,disc', complete with flexible hose and hand shower, with storage tray ,disc', transparent crystal

H3213310041211



Single lever basin mixer, projection 115 mm, fixed spout, with / without pop-up waste

H311331xxx1011 / H311331xxx1001



Concealed single lever basin mixer for Simibox 2-Point, projection 175 mm

H311336xxx1201



Twin handled concealed basin mixer, projection 175 mm

H3123360041201



Single lever bidet mixer, projection 110 mm, fixed spout, with pop-up waste

H341331xxx1011 / H341331xxx1031



Wall-mounted single lever shower mixer, with one outlet, with / without accessories

H3313370041411 / H3313370044001



Storage tray ,disc', for wall tray, toilet paper holder and faucets ,disc' with Ø 185 mm, plastic
185 x 185 x 15 mm

H398335xxx0011



Storage tray ,disc', for column single lever bath mixer ,disc', with Ø 275 mm, plastic
275 x 275 x 15 mm

H398335xxx0021

Colours Faucets

	.004 Chromed
	.090 PVD brushed stainless steel
	.001* PVD gold
	.081* PVD titanium black matt
	.082* PVD rose gold

* special colors available on demand

Colours Discs

	.081 Amber
	.082 Tangerine orange
	.084 Transparent crystal
	.085 Smoky grey
	.090 Opaque white
	.091 Opaque black
	.092 Emerald green
	.093 Powder pink

Matching concealed systems can be found in the SIMIBOX & ROUGH- IN SETS chapter. Additional hand showers, shower systems and accessories can be found in the SHOWER ACCESSORIES chapter.

SENSE Design by Peter Wirz



SENSE single lever basin mixer KARTELL BY LAUFEN washbasin 120, tray right; mirror 'All Saints'

NEW FAUCETS

Modern, abstract, geometric – SENSE faucets send a clear signal. However, you cannot help but notice the sweeping proportions which account for the charm of the water dispensers. They look fresh and extremely contemporary with their borrowing of industrial elements. This is how fine art is defined in design.

SENSE



SENSE Twin handled set for concealed thermostatic bath/shower mixer; hand and head shower



SENSE single lever bath mixer; hand shower



SENSE column single lever basin mixer VAL small washbasin 50 with semi-wet area



SENSE single lever basin mixer



Single lever basin mixer, projection 106 mm, Eco+, fixed spout, with / without pop-up waste

**H3113910041111 /
H3113910041101**



Single lever basin mixer, projection 130 mm, Eco+, fixed spout, with / without pop-up waste

**H3113910041211 /
H3113910041201**



Column single lever basin mixer, projection 170 mm, Eco+, fixed spout, without pop-up waste

H3113980041201



Single lever bidet mixer, projection 110 mm, Eco+, fixed spout, with pop-up waste

H3413910041111



Wall-mounted single lever bath mixer, with diverter, with / without accessories

**H3213970041311 /
H3213970044001**



Wall-mounted single lever shower mixer, with one outlet, with / without accessories

**H3313970041311 /
H3313970044001**



Twin handled set for concealed thermostatic bath/shower mixer, with 2-way dimmer

**H3233960040001 /
H3233960040101**



Twin handled set for concealed thermostatic shower mixer, with 1-way dimmer

H3333960040001



Wall-mounted spout, fixed spout, projection 126 mm

H3713900040601



Hand shower, 1 shower jet

H3613930041211

Colours **Faucets**

.004
Chromed

Matching concealed systems can be found in the SIMIBOX & ROUGH-IN SETS chapter. Additional hand showers, shower systems and accessories can be found in the SHOWER ACCESSORIES chapter.



VAL bowl washbasin, rectangular; column single lever basin mixer



VAL wall-mounted basin mixer; drop-in washbasin
BOUTIQUE made to measure countertop, 120 mm thick



VAL bathtub, oval; wall-mounted bath mixer

VAL FAUCETS

Grcic complements Grcic to perfection of VAL. Because only Grcic thinks Grcic and is able to fuse its pure formal language unparalleled with the most modern faucet technology to create one unit.

Matching concealed systems can be found in the SIMIBOX & ROUGH-IN SETS chapter. Additional hand showers, shower systems and accessories can be found in the SHOWER ACCESSORIES chapter.

Colours **Faucets**



Single lever basin mixer, projection 110 mm, Eco+, fixed spout, without / with pop-up waste

**H3113810041101 /
H3113810041111**



Single lever basin mixer, projection 140 mm, Eco+, fixed spout, without / with pop-up waste

**H3113810041201 /
H3113810041211**



Column single lever basin mixer, projection 190 mm, Eco+, fixed spout, without pop-up waste

H3113880041301



Concealed single lever basin mixer for Simibox 2-Point, fixed spout, projection 180 mm

H3113860041201



Single lever bidet mixer, projection 121 mm, Eco+, fixed spout, with pop-up waste

H3413810041111



Wall-mounted single lever bath mixer, with diverter, without / with accessories

**H3213870044001 /
H3213870041311**



Wall-mounted single lever shower mixer, with one outlet, without / with accessories

**H3313870044001 /
H3313870041311**



Set for concealed single lever bath mixer, with diverter / with integrated vacuum breaker

**H3213860040001 /
H3213860040101**



Set for concealed single lever shower mixer, with one outlet

H3313860040001



Wall-mounted spout, fixed spout, projection 175 mm

H3713800040601



Extension ring ,twin' 15 mm, matches round set

15 mm
H3799840040501



Extension ring ,twin' 30 mm, matches round set

30 mm
H3799840040601

CURVEPRIME



CURVEPRIME single lever basin mixer



CURVEPRIME twin handled basin mixer



CURVEPRIME 3-hole basin mixer

PERFECTION AND DYNAMICS

Water for the senses: The characteristic feature of CURVEPRIME is the elegant, arch-shaped outlet that describes the path of water in a sensual way.



CURVEPRIME twin handled concealed basin mixer

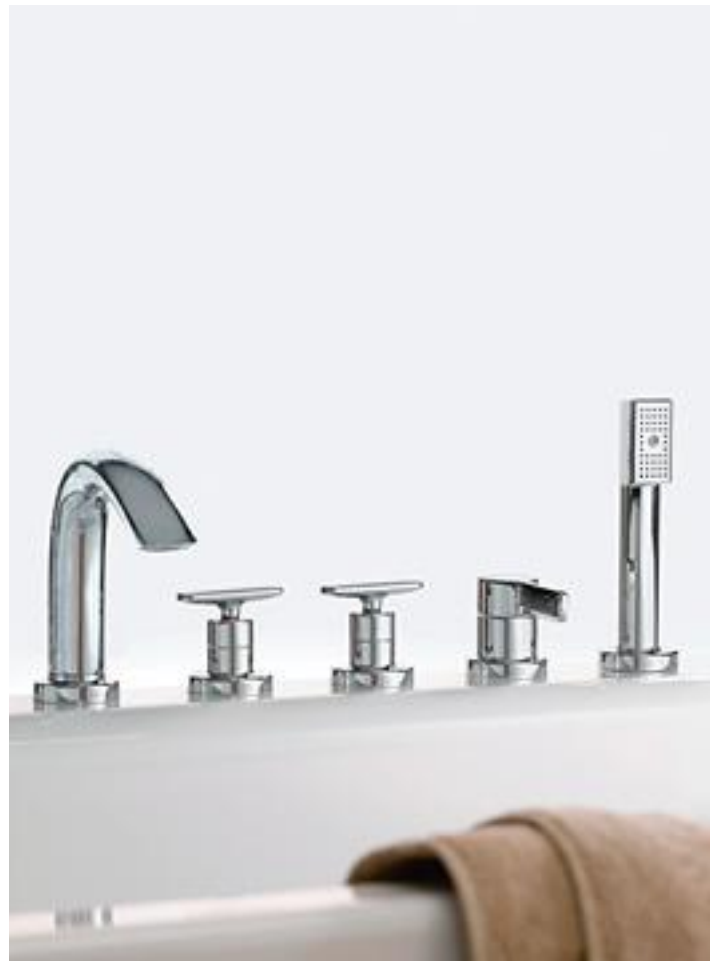

CURVEPRIME 5-hole deck-mounted bath mixer

CURVEPRIME



Single lever basin mixer, projection 115 mm, swivel spout, without / with pop-up waste

**H3117010042101 /
H3117010042111**



Single lever basin mixer, projection 150 mm, swivel spout, without / with pop-up waste

**H3117010042201 /
H3117010042211**



Twin handled basin mixer, projection 115/ 150 mm, swivel spout, with pop-up waste

**H3127010042111 /
H3127010042211**



3-hole basin mixer, projection 150 mm, swivel spout, with pop-up waste

H3127030042211



Wall-mounted thermostatic shower mixer, with one outlet, with / without accessories

**H3337070041451 /
H3337070044001**



Set for concealed single lever bath mixer, with 2-way diverter / with integrated vacuum breaker

**H3217060040001 /
H3217060040101**



Set for concealed shower mixer, with one outlet

H3317060040001



Wall-mounted spout, projection 190 mm

H3717000040601



Extension ring ,twin' 15 mm, matches round set

15 mm

H3799840040501



Extension ring ,twin' 30 mm, matches round set

30 mm

H3799840040601



Twin handled concealed basin mixer, projection 190 mm

H3127060041201



Single lever bidet mixer, projection 105 mm, fixed spout, with pop-up waste

H3417010041111



Twin handled bidet mixer, projection 105 mm, fixed spout, with pop-up waste

H3427010041111



Wall-mounted thermostatic bath mixer, with 2-way diverter, with / without accessories

H3237070041451 / H3237070044001



4-hole deck-mounted bath mixer, without spout, for external water inlet, with / without mounting plate

H3227040042841 / H3227049042841



5-hole deck-mounted bath mixer, spout 225 mm, with / without mounting plate

H3227050042841 / H3227059042841



5-hole deck-mounted bath mixer, spout 150 mm, with / without mounting plate

H3227050043841 / H3227059043841

Colours **Faucets**

.004
Chromed

Matching concealed systems can be found in the SIMIBOX & ROUGH-IN SETS chapter. Additional hand showers, shower systems and accessories can be found in the SHOWER ACCESSORIES chapter.

TWINPLUS



TWINPLUS single lever basin mixer



TWINPLUS column single lever mixer



TWINPLUS single lever shower mixer with hand shower and rain shower head

ROOM FOR EXPANSION

Strong and expressive, those are the characteristics of TWINPLUS. The design-oriented complete solution is an indispensable design element in any modern bathroom.



TWINPLUS wall-mounted single lever bath mixer with hand shower

TWINPLUS



Single lever basin mixer, projection 109 mm, fixed spout, without / with pop-up waste

**H3116210041101 /
H3116210041111**



Single lever basin mixer, projection 140 mm, fixed spout, without / with pop-up waste

**H3116210041201 /
H3116210041211**



Single lever basin mixer, projection 160 mm, swivel spout, without / with pop-up waste

**H3116210042201 /
H3116210042211**



Column single lever basin mixer, projection 180 mm, height at the aerator 190 / 240 mm, fixed spout, without pop-up waste

**H3116280041301 /
H3116280041401**



Wall-mounted single lever bath mixer, with 2-way diverter, with / without accessories

**H3216270041361 /
H3216270044001**



Wall-mounted single lever shower mixer, with one outlet, with / without accessories

**H3316270041361 /
H3316270044001**



Wall-mounted thermostatic bath mixer, with 2-way diverter, with / without accessories

**H3236270041361 /
H3236270044001**



Wall-mounted thermostatic shower mixer, with one outlet, with / without accessories

**H3336270041361 /
H3336270044001**



Twin handled set for concealed thermostatic bath mixer, with 2-way diverter / with integrated vacuum breaker

**H3236260042001 /
H3236260042101**



Twin handled set for concealed thermostatic shower mixer, with one outlet

H3336260042001



Concealed single lever shower mixer for Simibox 1-Point, with accessories

H3316290041311



Wall-mounted spout, projection 185 mm

H3716200040601



Extension ring, twin' 15 mm, matches round set

15 mm

H3799840040501



Extension ring, twin' 30 mm, matches round set

30 mm

H3799840040601

For more details see separately available technical catalogue



Concealed single lever basin mixer for Simibox 2-Point, fixed spout, projection 195 mm

H3116260041201



Concealed single lever basin mixer for Simibox 1-Point, swivel spout, projection 175 / 225 mm

H3116290042201 / H3116290042301



Concealed single lever basin mixer for Simibox 1-Point, swivel spout, projection 175 / 225 mm

H3116290042201 / H3116290042301



Single lever bidet mixer, projection 112 mm, fixed spout, with pop-up waste

H3416210041111



Set for concealed single lever bath mixer, with 2-way diverter / with integrated vacuum breaker

H3216260040001 / H3216260040101



Set for concealed single lever shower mixer, with one outlet

H3316260040001



Set ,comfort' for concealed thermostatic bath mixer, with 2-way diverter / with integrated vacuum breaker

H3236260045001 / H3236260045101



Set ,comfort' for concealed thermostatic shower mixer, with one outlet

H3336260045001

Colours **Faucets**

.004
Chromed

Matching concealed systems can be found in the SIMIBOX & ROUGH-IN SETS chapter.
Additional hand showers, shower systems and accessories can be found in the SHOWER ACCESSORIES chapter.

CITYPLUS



CITYPLUS single lever basin mixer



CITYPLUS column single lever basin mixer

A STATEMENT FOR URBAN LIVING

Generous surfaces and a fascinating design are the characteristics of the CITYPLUS series.



CITYPLUS column single lever basin mixer



CITYPLUS single lever bath mixer with hand shower

CITYPLUS



Single lever basin mixer, projection 115 mm, fixed spout, without / with pop-up waste

**H3117510041101 /
H3117510041111**



Single lever basin mixer, projection 140 mm, fixed spout, without / with pop-up waste

**H3117510041201 /
H3117510041211**



Column single lever basin mixer, projection 191 mm, fixed spout, without pop-up waste

H3117580041301



Concealed single lever basin mixer for Simibox 2-Point, fixed spout, projection 185 mm

H3117560041201



Wall-mounted thermostatic shower mixer, with one outlet, without accessories

H3337570044001



Set for concealed single lever bath mixer, with 2-way diverter, without / with integrated vacuum breaker

**H3217560040001 /
H3217560040101**



Set for concealed single lever shower mixer, with one outlet

H3317560040001



Twin handled set for concealed thermostatic bath mixer, with 2-way dimmer / with integrated vacuum breaker

**H3237560042001 /
H3237560042101**



Extension ring 'city' 15 mm, matches angular set

15 mm

H3799840040701



Extension ring 'city' 30 mm, matches angular set

30 mm

H3799840040801



Single lever bidet mixer, projection 105 mm, fixed spout, with pop-up waste

H3417510041111



Wall-mounted single lever bath mixer, with 2-way diverter, with / without accessories

**H3217570041361 /
H3217570044001**



Wall-mounted single lever shower mixer, with one outlet, with / without accessories

**H3317570041361 /
H3317570044001**



Wall-mounted thermostatic bath mixer, with 2-way diverter, without accessories

H3237570044001



Twin handled set for concealed thermostatic shower mixer, with one outlet

H3337560042001



Wall-mounted spout, projection 185 mm

H3717500040601



Thermostatic showerstation, rain shower head, 300x300 mm, complete with accessories

H3337570045361

Colours **Faucets**



.004

Chromed

Matching concealed systems can be found in the SIMIBOX & ROUGH-IN SETS chapter.
Additional hand showers, shower systems and accessories can be found in the SHOWER ACCESSORIES chapter.

CITYPRO



CITYPRO single lever basin mixer



CITYPRO column single lever basin mixer



CITYPRO single lever bidet mixer

TIMELESS DESIGN LANGUAGE FOR THE BATHROOM

Fascinating design and high functionality. Elegant and pleasing shapes for the hand. The CITYPRO series meets the spirit of the times of modern living.



CITYPRO single lever shower mixer with hand shower



CITYPRO single lever bath mixer with hand shower

CITYPRO



Single lever basin mixer, projection 110 mm, without / with pop-up waste

**H3119510041101 /
H3119510041111**



Single lever basin mixer, projection 140 mm, without / with pop-up waste

**H3119510041201 /
H3119510041211**



Column single lever basin mixer, projection 190 mm, without pop-up waste

H3119515041301



Wall-mounted single lever basin mixer, projection 167 / 217 mm

**H3119570042201 /
H3119570042301**



Wall-mounted thermostatic bath mixer, with 2-way diverter, without accessories

H3239570044001



Wall-mounted thermostatic shower mixer, with one outlet, without accessories

H3339570044001



Set for concealed single lever bath mixer, with 2-way diverter, without / with integrated vacuum breaker

**H3219560040001 /
H3219560040101**



Set for concealed shower mixer, with one outlet

H3319560040001



Cold water tap, projection 110 mm, without pop-up waste

H3119580041101



Single lever bidet mixer, projection 96 mm, fixed spout, with pop-up waste

H3419510041111



Wall-mounted single lever bath mixer, with 2-way diverter, with / without accessories

H3219570041311 / H3219570044001



Wall-mounted single lever shower mixer, with one outlet, with / without accessories

H3319570041311 / H3319570044001



Wall-mounted spout, projection 185 mm

H3719500040601



Thermostatic showerstation, rain shower head, Ø 200 mm, complete with accessories

H3339570045361



Extension ring ,twin' 15 mm, matches round set

15 mm

H3799840040501 / H3799840040601

Colours **Faucets**

.004
Chromed

Matching concealed systems can be found in the SIMIBOX & ROUGH-IN SETS chapter.
Additional hand showers, shower systems and accessories can be found in the SHOWER ACCESSORIES chapter.

LAURIN



LAURIN single lever basin mixer

LAURIN

A perfect match of form and function: the Laurin series represents excellent value matched with best energy ratings, promising low water consumption. A minimalist yet attractive design, it is the perfect fit for any bathroom.



Single lever basin mixer, projection 106 mm, fixed spout, without / with pop-up waste

**H3112010041101 /
H3112010041111**



Single lever basin mixer, projection 130 mm, fixed spout, without / with pop-up waste

**H3112010041201 /
H3112010041211**



Column single lever basin mixer, projection 130 mm, fixed spout, without pop-up waste

H3112080041201



Single lever bidet mixer, projection 105 mm, fixed spout, with pop-up waste

H3412010041111



Wall-mounted single lever bath mixer, with 2-way diverter, with / without accessories

**H3212070041311 /
H3212070044001**



Wall-mounted single lever shower mixer, with one outlet, with / without accessories

**H3312070041311 /
H3312070044001**



Set for concealed single lever bath mixer, with 2-way diverter, without / with integrated vacuum breaker

**H3212060040001 /
H3212060040101**



Set for concealed single lever shower mixer, with one outlet

H3312060040001

Colours **Faucets**



Matching concealed systems can be found in the **SIMIBOX & ROUGH-IN SETS** chapter. Additional hand showers, shower systems and accessories can be found in the **SHOWER ACCESSORIES** chapter.

SIMIBOX

1-Point & 2-Point

Simibox 1-Point and Simibox 2-Point enable a completely new faucet design for concealed wall and shower mixers. Thanks to the intelligent flush-mounting box, the fittings can be reduced to the essentials. Slim shapes and the finest faucets for a sophisticated appearance in the bathroom.



Simibox 1-Point



Simibox 2-Point
(for Kartell by LAUFEN
and VAL) lever right



Simibox 2-Point
(for Twinplus)
lever right / left / top

Installation examples



Shower mixer Twinplus
with Simibox 1-Point



Wall-mounted mixer Twinplus with
Simibox 2-Point



	Twinplus	Twinplus	Twinplus	The New Classic	Kartell by LAUFEN	VAL
Simibox 1-Point 37698.1.000.100.1	31162.9.004.220.1 31162.9.004.230.1	33162.9.004.131.1 33162.9.004.000.1				
Simibox 2-Point Handle right 37698.1.000.251.1				31185.6.004.120.1	31133.6.004.120.1	31138.6.004.120.1
Simibox 2-Point Handle left 37698.1.000.351.1			31162.6.004.120.1			
Simibox 2-Point Handle left 37698.1.000.352.1			31162.6.004.120.1			
Simibox 2-Point Handle on top 37698.1.000.353.1			31162.6.004.120.1			

SIMIBOX Three boxes, many advantages

The concealed Simibox system combines ingenious technology and easy handling with high design standards. Choose the Simibox Standard with integrated stop valves and reversible supply and outlet pipes or one of the simpler Simibox Light versions, depending on the local conditions.



Simibox Light with stop valves
37898.0.000.100.1





Simibox Standard with stop valves
Supply and outlet pipes reversible
37898.0.000.000.1



Pre-assembled set
with functional unit
and decorative finish

Simibox Light without stop valves
37898.0.000.101.1



	Recess depth	With stop valves	Positional correction up to 5°	Supply and outlet connections reversible	Fits mechanical pre-assembled sets	Fits thermostatic pre-assembled sets	Pre-assembled set can later be exchanged/replaced
 Simibox Light 37898.0.000.101.1	min. 74 mm				✓	✓	✓
 Simibox Light 37898.0.000.100.1	min. 74 mm	✓			✓	✓	✓
 Simibox Standard 37898.0.000.000.1	min. 102 mm	✓	✓	✓	✓	✓	✓



Integrated stop valves

Just turn two screws and the water stops. The local stop valves facilitates any necessary service quickly and easily without having to turn off the water in the entire building.

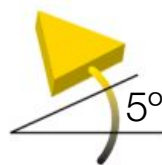

Simple positional correction after installation by up to 5°

If the box is not installed exactly level, the functional box of the Simibox Standard can later be adjusted by 5° on both sides.

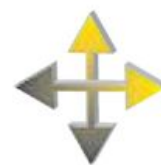

Flexible

The connections for the supply lines and mixed water outlets can easily be reversed on the Simibox Standard.

SIMIBOX

Concealed system for all design ranges

Cutting-edge technology behind the wall means nothing without attractive packaging to round it off. The high-quality design of our concealed mixer perfectly complements the shower and bath experience. The pre-assembled kit is made up of the functional unit, together with the corresponding decorative elements, and is available to match all our design ranges. If new forms are required, a replacement is possible in next to no time. Whether you are looking for classical elegance, futuristic boldness or everyday simplicity – LAUFEN concealed mixers have something for every taste.

Pre-assembled kits					
Mechanical	THE NEW CLASSIC	KARTELL BY LAUFEN	VAL	CURVEPRIME	LAURIN
Without diverter	33185.6.004.000.1	33133.6.004.000.1	33138.6.004.000.1	33170.6.004.000.1	33120.6.004.000.1
With diverter	32185.6.004.000.1	32133.6.004.000.1	32138.6.004.000.1	32170.6.004.000.1	32120.6.004.000.1
With diverter and vacuum breaker	32185.6.004.010.1	32133.6.004.010.1	32138.6.004.010.1	32170.6.004.010.1	32120.6.004.010.1

Thermostatic	SENSE	TWINPLUS	TWINPLUS „COMFORT“
Without diverter	33339.6.004.000.1	33362.6.004.000.1	3.3362.6.004.500.1
With diverter	32339.6.004.000.1	32362.6.004.000.1	3.2362.6.004.500.1
With diverter and vacuum breaker	32339.6.004.010.1	32362.6.004.010.1	3.2362.6.004.510.1

		
TWINPLUS	CITYPLUS	CITYPRO
33162.6.004.000.1	33175.6.004.000.1	33195.6.004.000.1
32162.6.004.000.1	32175.6.004.000.1	32195.6.004.000.1
32162.6.004.010.1	32175.6.004.010.1	32195.6.004.010.1

		
TWINPLUS 2-handle	CITYPLUS	CITYPLUS 2-handle
33362.6.004.200.1	33375.6.004.000.1	33375.6.004.200.1
32362.6.004.200.1	32375.6.004.000.1	32375.6.004.200.1
32362.6.004.200.1	32375.6.004.010.1	32375.6.004.210.1

SIMIBOX & ROUGH-IN SETS



Concealed installation unit, recess depth of at least 102 mm, with stop valves, supply and outlet pipes reversible

102-132 mm
H3789800000001



Concealed installation unit 'light', reduced recess depth of at least 74 mm, with / without stop valves

74-104 mm
H3789800001001 / H3789800001011



Simibox 1-Point concealed installation unit

H3769810001001



Concealed installation unit for Simibox 2-Point, lever right, matches twinplus

H3769810003511



Rough-in set for column bath mixer

H3709850000001



Extension set 25 mm for concealed twin handled concealed basin mixer

25 mm
H3767040000501



Extension set 25 mm for Simibox 1-Point

25 mm
H3769840001251



Mandatory complementary set for Simibox/Simibox 'light', for installing a concealed washbasin tap with IR sensor

H3779800000101



Mounting aid for Simibox/Simibox 'light'

H3799800030001



Extension set 25 mm for Simibox 2-point, matches Kartell by Laufen/VAL

H3799840002251



Extension set 25 mm for Simibox 2-point, matches twinprime/twinplus

H3799840002351



Extension ring 'twin' 15 mm, matches round set

15 mm
H3799840040501

SIMIBOX & ROUGH-IN SETS



Concealed installation unit for Simibox 2-Point, lever left, matches twinplus

H3769810003521



Concealed installation unit for Simibox 2-Point, lever above, matches twinplus

H3769810003531



Concealed installation unit for Simibox 2-Point, lever right, matches Kartell by Laufen/VAL/cityplus/The New Classic

H3769810002511



Rough-in set for concealed twin handled concealed basin mixer

H3769820001001



Mounting aid for Simibox 1-Point

H3779800030001



Extension set 25 mm for Simibox/Simibox ,light'

25 mm
H3799800000501



Extension set 50 mm for Simibox/Simibox ,light'

50 mm
H3799800000601



Mounting flange for Simibox, usable as mounting aid or backing flange for pre-wall installation

H3799800005001



Extension ring ,twin' 30 mm, matches round set

30 mm

H3799840040601



Extension ring ,city' 15 mm, matches angular set

15 mm

H3799840040701



Extension ring ,city' 30 mm, matches angular set

30 mm

H3799840040801

TWINTRONIC DIGITAL PUBLIC BATHROOM



TWINTRONIC electronic concealed basin mixer with IR sensors

Infra-red controllers - flexible technology for all needs

The future of the faucet: contactless, hygienic, vandalproof, and efficient. Infra-red technology can save up to 70% water compared to conventional faucets and the easy-to-clean shape makes it very hygienic. Ideal for public and semi-public installation: Low consumption and maintenance costs even during maximum use. Ideal for hospitals, sport arenas, schools, airports, railway stations, gyms and restaurants.



The water flow starts as soon as your hands enter the detection area.

HYGIENIC AND EFFICIENT

The TWINTRONIC concealed solution facilitates particularly space-saving design for public washrooms. TWINTRONIC can be installed with the Simibox Standard & Simibox Light concealed system.



Concealed basin mixer, with electronic control, manual temperature setting, projection 175 mm, fixed spout, battery operated (6V) / mains operated (230V), with Bluetooth adapter

3166474043211 / 3166474043221



Concealed basin mixer, with electronic control, manual temperature setting, projection 200 mm, fixed spout, battery operated (6V) / mains operated (230V), with Bluetooth adapter

3166474043411 / 3166474043421



Concealed basin mixer, with electronic control, manual temperature setting, projection 225 mm, fixed spout, battery operated (6V) / mains operated (230V), with Bluetooth adapter

3166474043311 / 3166474043321



Concealed basin tap, with electronic control, for connection to cold or mixed water, projection 175 mm, fixed spout, battery operated (6V) / mains operated (230V), with Bluetooth adapter

3176474043211 / 3176474043221



Concealed basin tap, with electronic control, for connection to cold or mixed water, projection 225 mm, fixed spout, battery operated (6V) / mains operated (230V), with Bluetooth adapter

3176474043311 / 3176474043321



Concealed basin tap, with electronic control, for connection to cold or mixed water, projection 200 mm, fixed spout, battery operated (6V) / mains operated (230V), with Bluetooth adapter

3176474043411 / 3176474043421

The matching concealed system can be found in the SIMIBOX chapter.

SHOWER ACCESSORIES

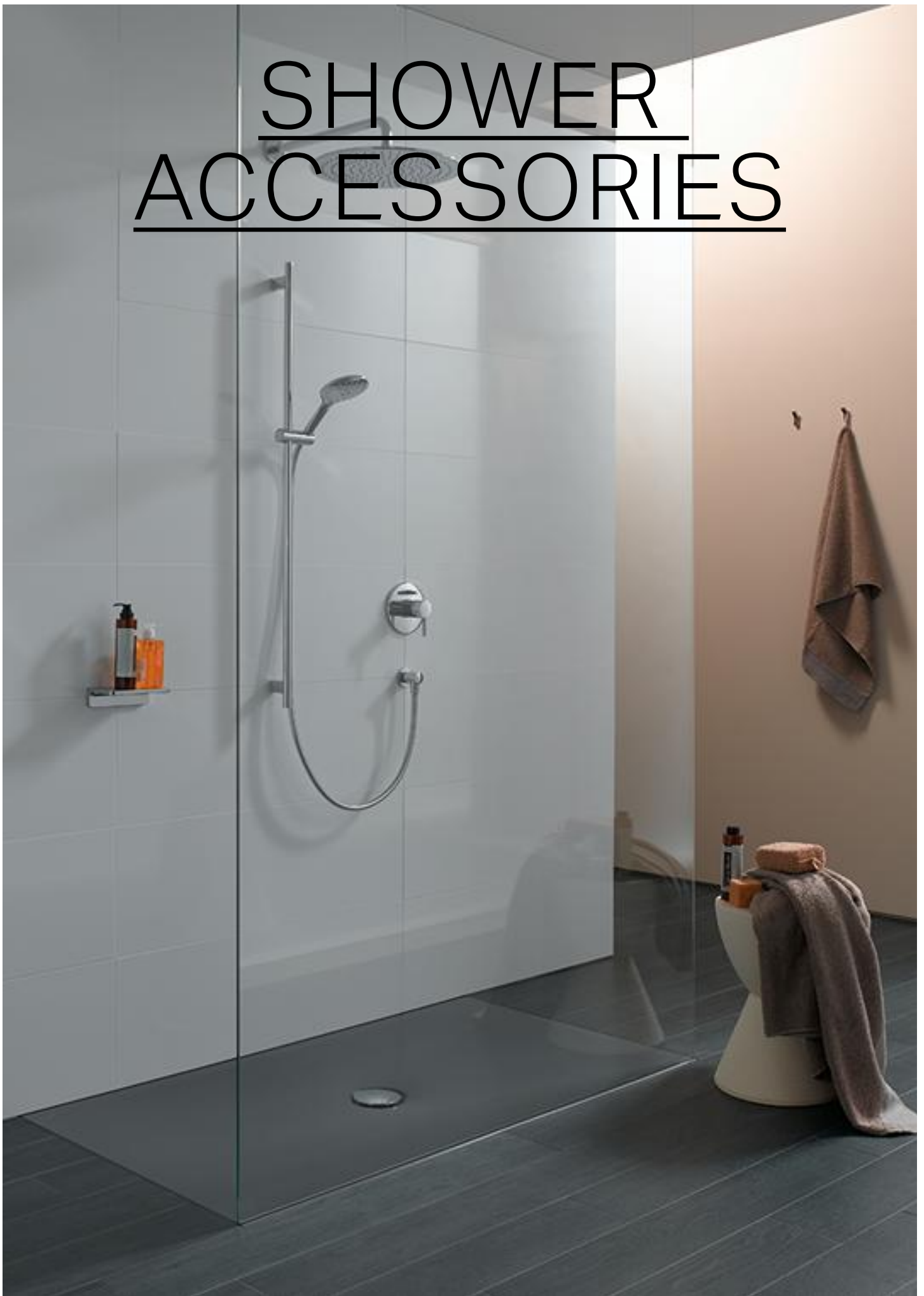

MYTWIN rain shower head, round, 120; hand shower

GENTLE FRESHNESS

The rain shower heads made of high quality stainless steel are supplemented by versatile hand shower heads in various formats. Matching shower accessories are perfectly harmonised with the various shower heads. From the convenient wall support to the carefully designed shower slide bar with sophisticated side-mounted controls, it provides the best possible solution for all needs.



MYTWIN hand shower



MYTWIN rain shower, round, 100; hand shower

SHOWER ACCESSOIRES



TWINPLUS

Thermostatic showerstation, rain shower head, Ø 300 mm, complete with accessories

H3336270045361



CITYPLUS

Thermostatic showerstation, rain shower head, 300x300 mm, complete with accessories

H3337570045361



Square rain shower head

202 x 202 / 242 x 242 mm

H3679810041101 / H3679810041201



Square rain shower head

302 x 302 / 353 x 353 mm

H3679810041301 / H3679810041401



Round rain shower head, ultra flat, Ø 300 mm, brushed stainless steel

Ø 300 mm

H3679810032311



Ceiling bracket for rain shower head, with square rosette, 100 mm

100 mm

H3669800040011



Ceiling bracket for rain shower head, with round rosette, 100 mm

100 mm

H366980xxx0021



Wall bracket for rain shower head, with square rosette, 420 mm

420 mm

H3669800040031



MYTWIN

Hand shower ,MyTwin120', 3 spray jets

H3619820043711



MYCITY

Hand shower ,MyCity100', 1 spray jet

H3619830041511



MYCITY

Hand shower ,MyCity120', 3 spray jets

H3619830043711



TWINGLISS

Shower slide bar ,twingliss', all-metal

600 / 1100 mm

H364980xxx3101 / H3649800044101



CITY

Shower hose connector ,city', projection 77 mm, with check-valve, all-metal

H3639800041611



TWIN

Shower hose connector with integrated ,twin' shower holder, projection 77 mm, with vacuum breaker, all-metal

H3639800041521



CITY

Shower hose connector with integrated ,city' shower holder, projection 77 mm, with vacuum breaker, all-metal

H3639800041621



Flexible hose in metal look, 1250 / 1500 / 1800 mm

1250 / 1500 / 1800 mm

H3629800001201 / H3629800001301 / H362980xxx1401

For more details see separately available technical catalogue

SHOWER ACCESSOIRES



Round rain shower head

Ø 206 / Ø 247 mm

**H3679810042101 /
H3679810042201**



Round rain shower head

Ø 306 / Ø 356 mm

**H3679810042301 /
H3679810042401**



Square rain shower head, 222 x 342 mm

222 x 342 mm

H3679810043101



Oval rain shower head, 226 x 346 mm

226 x 346 mm

H3679810044101



Wall bracket for rain shower head, with round rosette, 420 mm

420 mm

H366980xx0041



TWINSTICK

Hand shower 'twinstick', 1 spray jet

H3619820041251



CITYSTICK

Hand shower, 1 shower jet

H3619830901211



MYTWIN

Hand shower 'MyTwin100', 1 spray jet

H3619820041511



CITYGLISS

Shower slide bar 'CityGliss', all-metal

1030 mm

H3649800045001



TWIN

Fixed 'twin' shower holder, projection 52 mm, all-metal

H3699800042011



CITY

Fixed 'city' shower holder, projection 52 mm, all-metal

H3699800043011



TWIN

Shower hose connector 'twin', projection 77 mm, with check-valve, all-metal

H3639800041511

Colours Faucets



.004

Chromed



.090*

PVD Inox brushed

* not all models are available in all colors. More details on the technical pages or on our website.



PRODUCT FEATURES AND BENEFITS

SANITARY WARE

Sanitary ware production: Tradition and innovation



The basic ingredients for making ceramics have always been naturally occurring raw materials: Kaolinite, clay, feldspar and quartz sand form the basis for this extremely durable and hard material. The individual components of this malleable material are combined, homogenised and cleaned as part of a unique and very protracted process at LAUFEN. The resulting slurry – the pourable starting material for ceramics – is poured into pre-prepared plaster moulds or shaped using a special pouring process developed at LAUFEN.

The formability and pourability of the material allows the creation of a wide variety of sanitary ware products, but nevertheless always poses a manufacturing challenge, especially when creating objects with complex geometries.



Dried and glazed blanks are then baked in a kiln at temperatures up to 1240°C. Such extreme kiln temperatures ensure the hardness and durability of our high-quality LAUFEN products.

Ceramics, through their smooth, easy-to-clean surface, fulfil the highest hygiene standards – chemical acids, strong cleaning fluids or hydrochloric compounds hardly affect the material. Due to its light fastness, versatility and pleasant appearance, ceramic is the most popular material

used to manufacture high-quality sanitary fittings.

Top recycling qualities



Ceramic is the oldest malleable material used by mankind – and consists exclusively of naturally occurring raw materials. Ceramic is 100% recyclable and can be reintroduced into production processes as a ground powder or reused as a valuable raw material in other industries.

Ceramics or synthetic materials

Ceramic is the material which has been traditionally used in the bathroom over the centuries – and with good reason. The superiority of the material is evident, particularly in terms of hygiene, useful lifetime, environmental compatibility and durability. However, washbasins made of plastics and mineral-based cast materials are also available on the market, which present a design challenge to producers of sanitary ware. LAUFEN has always had a reputation as an innovator in the sanitary sector and is always striving

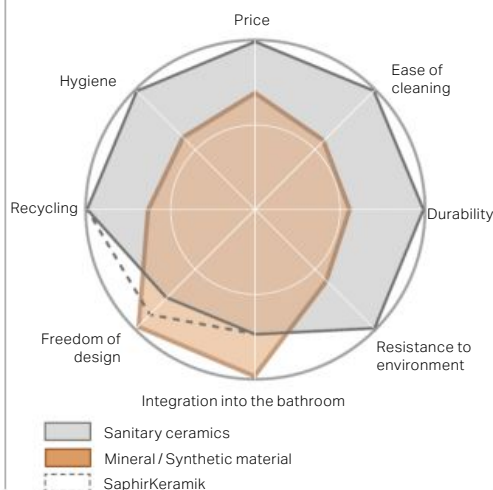

to improve the materials and production techniques it uses. As a result of these efforts, new ceramic compositions have been developed that allow smaller tolerances and even more precise corner radii or large flat ceramic items. Made to measure washbasin solutions ensure that ceramic sanitary ware can be fitted with millimetre precision into bathroom floor plans. Ceramics therefore deliver outstanding performance in all respects

 SaphirKeramik

A revolution in the formal language of ceramics



The innovative and high-quality composition of SaphirKeramik bestows possibilities and versatility never seen before upon the base material, enabling exceptional shaping. Edge radii of 1–2 mm are thus technically feasible. The new type of ceramic is considerably harder and has an improved bending strength. LAUFEN is thus able to produce thinner ceramic bodies, which reduces weight and the consumption of raw materials and energy. SaphirKeramik is not a replacement for any of the existing materials; instead, it broadens the range of forms of expression of the natural base material.

LCC Laufen Clean Coat

This innovative ceramic surface finish is a vitreous silicate ceramic coating on top of the original glaze. LCC is an extremely hard, indeed almost indestructible indivisible part of the ceramic object to which it is applied.

The benefits of this process: With a roughness of only 4 nanometers, LCC is entirely free of pores. Thanks to this feature, lime, dirt and bacteria have practically nowhere to gain a foothold – and even if they do, they can be removed much more easily. A hydrophilic effect caused by the material ensures that dirt particles are more easily washed away on flushing. In addition, cleaning and disinfection fluids spread over the surface more easily and thus work more effectively.

This is an ideal solution for the rigorous demands of everyday cleaning – for example in hotels or clinics – as LCC also means the sanitary ware is highly resistant to aggressive cleaning agents and chemicals. LCC ensures the highest standard of cleanliness and hygiene in the long-term. Even after years of use, the sanitary ware remains smooth and shiny, just as it was when it was brand new, in private bathrooms and public and semi-public areas.



Laufen Clean Coat LCC was awarded the iF material design award and nominated for the German Design Award.

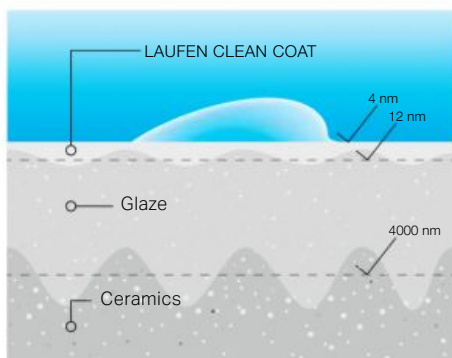

LAUFEN EasyFit



LAUFEN has developed a revolutionary wall fixation system for WCs, bidets and urinals. A patent has been lodged. The invisible, easy to mount fixation system meets the needs of both fitters and end users.

For example, end users are impressed by a ceramic WC with a flawless surface which is really easy to clean since there's nowhere for dirt to hide. Fitters are enthusiastic about the time-saving, intuitive mounting system



Comfortable lowering system



Thanks to our convenient **lowering system** many of our WC covers and seats close gently and quietly. For easier cleaning, all LAUFEN seats can be removed with a simple hand movement. LAUFEN seats have been comprehensively tested: amongst others the test includes opening and closing 50,000 times.



Vario Outlet



MAXIMUM WALL CLEARANCE FOR VERTICAL FLOOR OUTLET



MINIMUM WALL CLEARANCE FOR WALL FLOOR OUTLET



HORIZONTAL WALL OUTLET

The installation dimensions of WCs are not always identical: In many renovation situations the LAUFEN Vario outlet can make it easier to connect the WC to the sewage network. Both horizontal and vertical outlet wall clearances of up to 305 mm for washdown are possible.

Without flushing rim



Most of the bowls of the new LAUFEN WCs are rimless. There's no longer anywhere for dirt and deposits to hide; instead, thanks to an innovative and powerful flushing system, everything's flushed cleanly away with both the 6/3-litre version and the 4.5/3 litre version. Both public toilets and private bathrooms can benefit from the easy cleaning and great hygiene of this system.

Water saving WCs

The latest generation of LAUFEN water-saving WCs are optimised to a full flushing volume of 4.5 litres of water. Compared to today's 6/3 litre Dual-Flush these models provide substantial water savings. With an average of 5,000 flushes per WC per year, the yearly water saving is at least 6,000 litres, or more than 27,000 litres if we take into consideration that 9 or even 12 litre models are still in use. LAUFEN WCs marked with the green 4.5/3L logo are not only fulfilling the requirements defined in the harmonized standard EN 997 Class 1 Type 5 and Class 2 (that cover the whole European territory), but also fulfill the challenging Australian requirements of SAI/Wels 4 Stars.

For Laufen the European water label is the most reliable and transparent way for consumers and professionals to clearly appreciate the potential regarding the reduction of water consumption. LAUFEN toilets, cisterns and urinals are developed to reach the highest level of water saving performance. Please note that a suitable downstream drainage system must be built for this kind of water-saving WCs. In case of restrictions of the existing drainage system or local regulations LAUFEN WCs marked with green 4.5/3L logo can also be flushed with standard 6 litre flushing volume.



Flushing mechanisms



The flushing mechanism is the heart of every cistern from LAUFEN. In order to exceed current standards, the engineers of the Swiss bathroom specialist set themselves the highest quality goals during their extensive development programme.

This is also confirmed by the certifications e.g. by LGA and Q Plus. During development it was ensured that the flushing mechanisms were prepared for future development and were completely backwards compatible. Replacing "old for new" is thus no problem for sanitary technicians. The water supply options also offer flexibility, as they can be attached at the side, at the rear or from below.

The love of detail is proven by the elegant, independent design of the chrome-plated flush mechanism. The flushing mechanisms are produced completely within the European Union. Spare parts management and service are fully undertaken by LAUFEN.



Intelligent Control System



The intelligent control system has different modes and can trigger cleaning after each user or at defined intervals with different flush quantities of between 0.5 and 3 litres. Following long periods of non-use, a hygiene flush takes place every 24 hours by default. There is also an integrated overflow protection function in case the drain hole becomes blocked.

Hybrid mode

The urinal flushes at a predefined interval if usage is detected, and not after every single use. The flushing interval can be set to six different values between 1 h and 12 h. A predefined flushing volume is assigned to each flushing interval.

0-LITRE URINAL



The LAUFEN Lema 0-litre urinal saves water and money. It operates without water and does not require a water shut-off device or electricity to keep the drain closed. The urine itself helps to keep gases sealed in and to prevent their escape. The principle behind this "trap" is known in the chemical industry as the Erlenmeyer flask.



LEMA 0-LITER-URINAL SAVES WATER AND COSTS

Made-to-measure sanitary ware

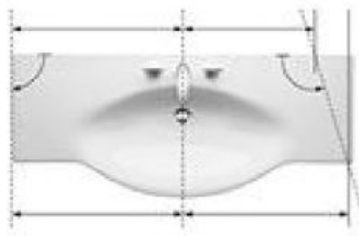

Many large LAUFEN washbasins can be manufactured made-to-measure at the factory. Using this innovative production technology, we can manufacture sanitary ware to fit the plan of your bathroom. The ceramic piece can be cut to size – even on the diagonal.

Sound insulation sets



The bathroom is private. So that it stays that way, LAUFEN provides sound insulation sets, consisting of specialised foam and rubber elements for its washbasins and wall-mounted WCs. These elements considerably reduce the amount of noise due to usage and functions that passes through the wall into neighbouring rooms.

Depending on the structural situation, a sound reduction of up to 9 decibels can be achieved, which means that noise is reduced by almost half.

These sets have been tested against DIN 4109 and certified by Fraunhofer.

- 89269.1 sound insulation set for washbasins up to 80 cm
- 89269.2 sound insulation set for washbasins of 80–100 cm
- 89269.3 sound insulation set for washbasins of 110–180 cm
- 89269.4 sound insulation set for EasyFit fixation system

WELLNESS

Bathtub and shower tray materials



When choosing the bathtub or shower tray, material choice depends on individual preference and intended use. In order to be able to provide the right solution for all situations, LAUFEN provides four different materials:

Sentec

Bathing in a bathtub made of solid surface material Sentec feels like being in a natural basin. Due to a high percentage of mineral particles, the surface feels smooth. The innovative material also allows an incredible freedom of design: almost every shape is feasible – from very organic to very straight and architectural. Furthermore the non-porous surface of the material is hygienic, durable, UV-resistant, highly resistant to scratches and can be effortlessly cleaned.

Steel

Bathtubs and shower trays in enamelled steel are hygienic, and resistant to acid, scratching, impacts and abrasion. LAUFEN steel bathtubs are produced using heavy 3 and 3.5 mm enamelled steel; they are extremely dimensionally stable and come with an anti-slip coating. In addition, they are fitted with a sound insulation system.

Acrylic

Bathtubs and shower trays made of sanitary acrylic have benefits due to the insulating properties of the material and its warm surface. Together with an underlay made of hard foam, the material helps your bath water retain its temperature for a long time. LAUFEN sanitary acrylic is integrally coloured, is light and colour fast and easy to clean.

Marbond

Marbond is a composite material made of two layers which are extremely well connected with each other: The basis is formed by a high-quality mineral casting material, the surface is coated with a two millimetre thick acrylic layer. Marbond is hygienic, easy to clean, temperature resistant according to EN 263 and anti-slip (class C).

Whirlpool

Wellness at home: LAUFEN combines the rejuvenating energy of water, air and underwater lighting for reviving massages in your own bathtub at home. A feast for the senses – in total privacy.

When ordering whirl systems, LAUFEN always recommends to order bathtubs with acrylic panels or to install removable tiled drywalls for easier access in case of maintenance. If you can't avoid bricking in the bathtub, please plan large inspection chambers of minimum size 50x50 cm so that technical parts remain accessible. The installation of an additional ventilation grill is compulsory.

Air nozzles



Up to 90 nozzles positioned in the bathtub floor effectively revive your body all over. The outlets are installed flush with the bathtub floor and therefore do not impede enjoyment of the whirlpool. The warm and tingling ozonised air is blown into the water via air conduits under the base of the tub. The system is self-drying and therefore hygienic and easy to maintain.

Lighting



Coloured lighting appeals to all senses. A LED strip in the overflow slot (used in Kartell by LAUFEN bathtubs) creates a relaxing atmosphere. Usually the colours of the LED lights change continuously, but one colour can also be selected via the sensor control system or remote control.

Sensors



The wellness functions of the LAUFEN whirlpool can also be controlled by touch-sensitive areas on the bathtub rim: The system is safe, scratch-resistant, hygienic and easy to clean – and does not detract from the aesthetic of the bathtub.

Styrofoam carrier



A bathroom which is installed properly and perfectly arranged helps to achieve a balanced and harmonic atmosphere. That's why LAUFEN offers a suitable styrofoam carrier for each drop-in bathtub (except the ones with whirl system). These carriers simplify the mounting of the bathtub enormously: mounting is quicker and cleaner, because there is no bricking necessary, and tiling is also much easier on the perfectly accurate surface of these unseen helpers.

Installation kit

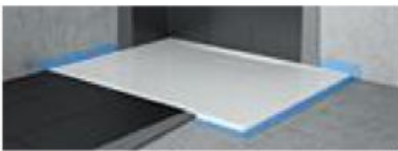

The LAUFEN installation kit made of hard foam allows a wide range of shower trays to be installed flush with the floor – and also assists with sound and heat insulation. A protective peripheral strip securely permanently prevents water from entering between the tiles and tray.



LAUFEN bathtubs and shower trays conform to applicable European standards and are tested and monitored on-site by the independent testing institute LGA Quali Test GmbH.

Sound insulation sets



LAUFEN sound insulation sets for bathtubs and shower trays significantly reduce the transmission of sound to neighbouring rooms and ensure a private, undisturbed bathing experience – without disturbing the neighbours. Irrespective of the structural conditions, a sound reduction of 10 or even 16 decibels can be achieved. Even a 10-decibel reduction corresponds to a 50% reduction in audible noise. LAUFEN sound insulation sets are tested against DIN 4109 and are certified by Fraunhofer.

Antislip



Antislip is a surface treatment which is applied to glazed and enamelled surfaces and then fired on and is thus optimally integrated into the surface structure. The surface offers a secure grip and is also easy to clean, and resistant to acids and scratching. Antislip has been tested against the German industrial standard DIN 51097 and offers higher than average antislip performance. With or without antislip, LAUFEN shower trays feel comfortable on the skin.

FURNITURE

Furniture surfaces



Furniture surfaces in the bathroom are designed to deal with the room's special climate conditions. LAUFEN provides a range of different surfaces, all optimised for their intended use and come with a guaranteed long useful life.

Real wood veneer

A cosy bathroom in wood. The classy wood veneers provide the haptics and optics of real wood. They are resistant to moisture and equipped with reinforced edges, making them resistant to impacts. These real wood veneers include those used in Lb3 and ILBAGNOLESSI One 'noce canaletto'.



HPL

HPL (High Pressure Laminate) surfaces are suitable for heavy use and are exceptionally durable, even with the look and feel of wood. They are easy to care for and clean, they are light-resistant and odourless and not sensitive to alcohol, organic solvents and water. HPL coatings are used by LAUFEN for the Space series.



Painted furniture surfaces

Our classic high-gloss paint finish, using two-component water-resistant paints, offers perfect surfaces with no unevenness and a wide range of colours. LAUFEN painted surfaces include the ILBAGNOLESSI One white furniture and LAUFEN also offers 39 additional special paints (shown on right) for the Case, Base, Space and Laufen Pro furniture ranges.



Film coatings

Film coatings are pulled over corners, thus ensuring the furniture surfaces are joint-free and not sensitive to water. They are scratch, water and light-resistant. Their flexibility offers a great deal of design freedom in terms of the forms used, such as integrated handles, for example. LAUFEN uses film coatings in its Palomba Collection, Living Square, Laufen Pro and Case ranges.

Storage systems



Tidy storage systems in drawers of the ILBAGNOLESSI One, Boutique and Space for VAL bathroom furniture range ensure tidy storage and prevent the return of chaos every time a drawer is closed fast.

Soft close



Slamming of doors is not inevitable: At LAUFEN, soft close means gently-closing furniture doors and drawers. The system is integrated as standard into all LAUFEN furniture. In this case, quality can be felt and not heard.



LIGHTS AND MIRRORS

3D mounting system



Comfort in every detail: The flexible and adjustable 3D mounting system makes installation LAUFEN furniture on the wall quick and easy.

Space saving siphon



LAUFEN undercounter furniture can optionally be equipped with an innovative space-saving siphon (1). This dispenses with the need for siphon cut-outs in the drawers (2), reclaims valuable storage space and ensures unlimited use of internal space.



Light in the bathroom



For bathing in light: with illuminated mirrors and mirror cabinets, LAUFEN offers a wide range of individual light solutions. From integrated LED lighting (1) to fitted, dimable LED lights (2) which offers useful light directly in front of the mirror for applying make up or shaving, to glass-edge lighting (3) attached on the cabinet shelving.

Sensor switch



As an option for Frame 25 mirrors, LAUFEN offers an integrated contact-free sensor switch for mirror lighting. This means you can switch the light on by putting your hand near the mirror, without having to touch the mirror at all.

FAUCETS

Eco & Eco+

Do your bit to save water and energy: even small changes make a big difference. Laufen has long been committed to preserving resources. For instance, through revolutionary technical solutions like the Ecototal control cartridge with integrated volume and hot water restraints, or the Eco and Eco+ water and energy-saving functions. These Eco functions make it easy for you to use less water and energy, and therefore do your bit for the environment. Faucets with the Eco+ function, for example, run cold water by default when the lever is in the central home position.

Faucets with the Eco function offer standard mixer functionality, but with temperature and volume restraints to help draw attention to excess consumption.

Eco

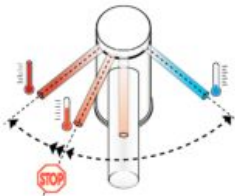

- Smart, no-nonsense resource-saving solution for private households
- 30 % reduction in water and energy consumption thanks to a water-saving flow regulator as well as volume (Flow-Control) and temperature restraints
- Long service life and low maintenance

Additional benefit of Eco+

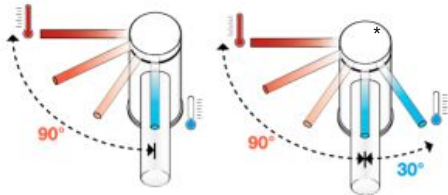

- No unintentional use of hot water as the faucet runs only cold water when the lever is in the central home position ('cold water start')

FlowControl

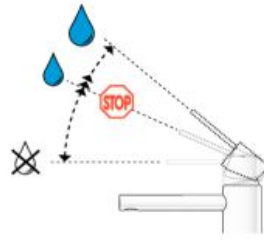

- A noticeable resistance is exerted by the volume restraint
- Once the volume restraint is overridden, the full volume of water is supplied

Thermostatic

Who isn't familiar with the situation? Fiddling with taps to get the temperature right before stepping into the bathtub or shower. Our user-friendly, highprecision thermostat mixers provide the answer.

Practical – smart technology at a second glance



The new generation of thermostatic mixers combine temperature and flow regulation at one side. The inner workings are also remarkable. The thermostatic mixers have a built-in safety function: if the supply of cold water should fail, the hot water is stopped automatically. And, thanks to the insulated hot water line, the faucet body never gets hot.

Space-saving – flush-mounted thermostats twinplus & cityplus



Outstanding thermostat technology in the most compact design. Flushmounted thermostat mixers offer the same convenience as surface-mounted versions. In addition, with the flush-mounted solution Simibox you can simply build the tech-

nology into the wall. This saves space, and depending on the bathroom design, achieves an elegant stylish solution.



Spot on – precision selection of water temperature



Simply set the degree and enjoy your shower at the temperature of your choice. Additional safety feature: the child-friendly stop button limits the temperature to 38 °C. You have to press and turn the button at the same time (see illustration 4) for hotter water.

Economical – infinitely adjustable water flow

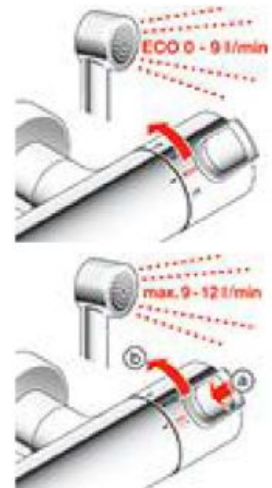

Regulate the water flow at the turn of a hand. Use the Eco button to easily save more water (see illustration 5). By pressing the stop button you leave the ECO range and the water runs at full flow (see illustration 6).

Showerstations



The new generation of showerstations offers a host of advantages that provide a unique showering experience: From simple designs to different settings and functions.

Slim, simple rain shower head



ø 300 mm or 300 x 300 mm, 2 mm thick, in chromed stainless steel, immediate non-drip water stop. shower head arm can be locked and swivelled horizontally by ±60°.

Adjustable wall mount



The water-carrying shower rail fastener can be adjusted during mounting:
 – height and lateral compensation ±5 mm
 – depth compensation -7 mm / +10 mm

Smooth MyTwin & MyCity handshower included



Luxury handshower with three spray modes and SmartSelect switchover function.

Easy handspray height adjustment



Push-action holder: simply press the button at the side, adjust height, let go and the spray is securely fixed.

One-handed thermostat control



Temperature and flow regulation at one side. Particularly helpful: thanks to smart water circulation, the faucet body does not get hot.

Discreet diverter



Positioned below the faucet, the simple and unobtrusive diverter switches from hand to rain spray.

Handshowers MyTwin & MyCity – Design with meticulous attention to detail

Convenience with a high pleasure factor



LAUFEN hand showers not only look smart, they are smart. The 120 mm sprays feature the "Rain-Spray" option, the "MassageSpray" and a combination of both spray types, the "MixedSpray". A press of the SmartSelect button switches conveniently between a gentle rain shower and vigorous massage spray.

The integrated air mix enhances the soft pleasant showering experience. Thanks to RubiClean limescale residues rub off quickly and easily to ensure many years of unadulterated showering pleasure.

Technically savvy



However LAUFEN's modern hand spray technology offers even more. All sprays are supplied with the "Ecochoice" limiter. It limits the water rate to 5.7 l/min and therefore bears the 'A' energy label. Anyone preferring a higher water flow of 11.3 l/min, can remove the controller manually. Special attention was paid to the choice of materials used. All water-conveying parts are made of quality materials that comply with drinking water ordinance requirements. Thanks to the smart technology inside the hand sprays do not heat up, and thus offer perfect protection against scalding.



RainSpray

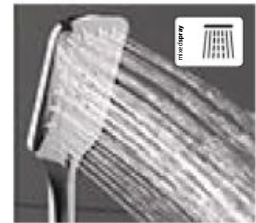

MixedSpray

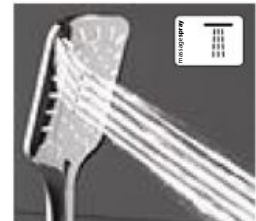

MassageSpray

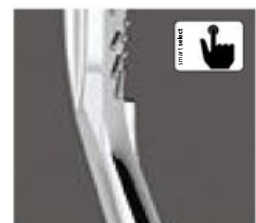

SmartSelect



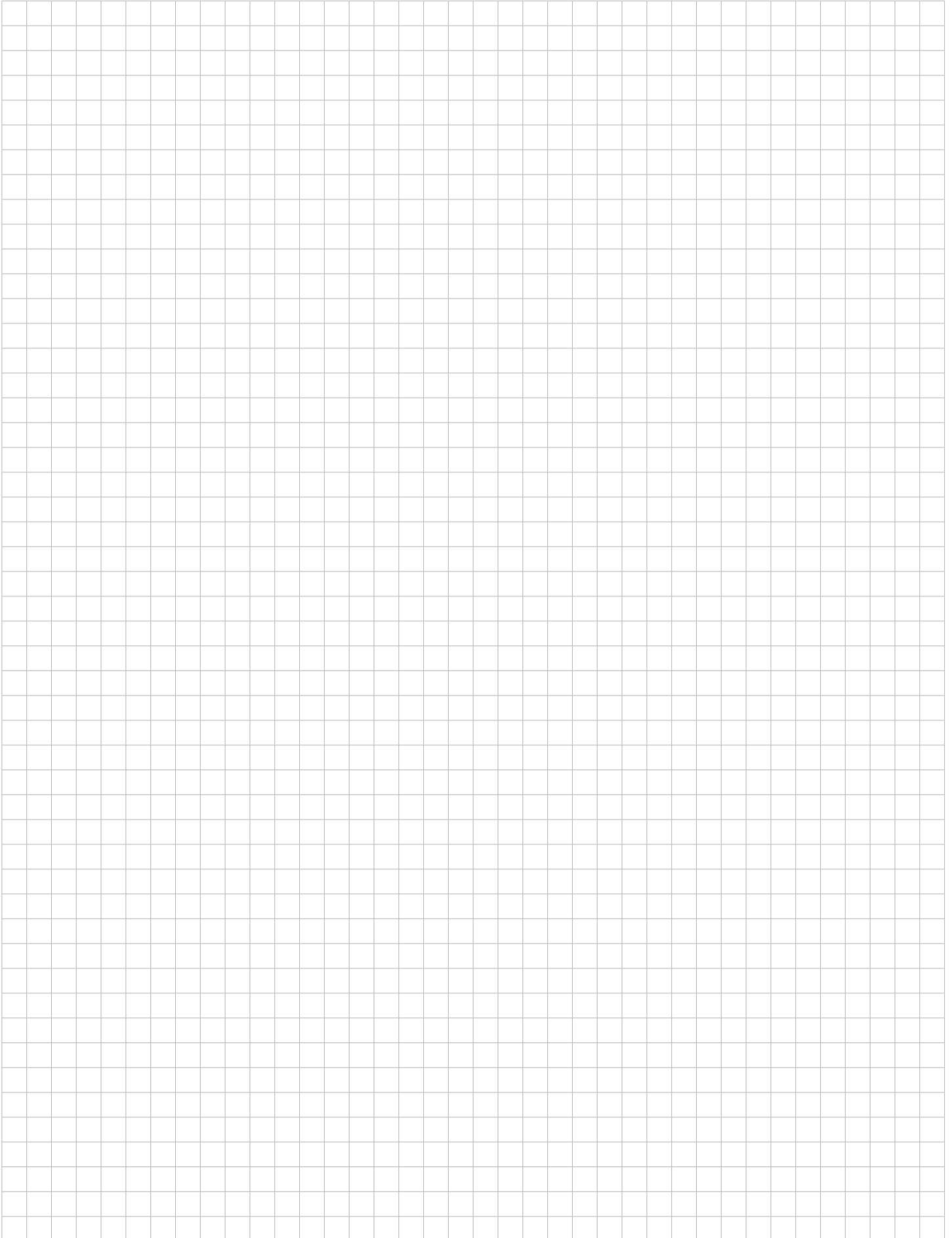

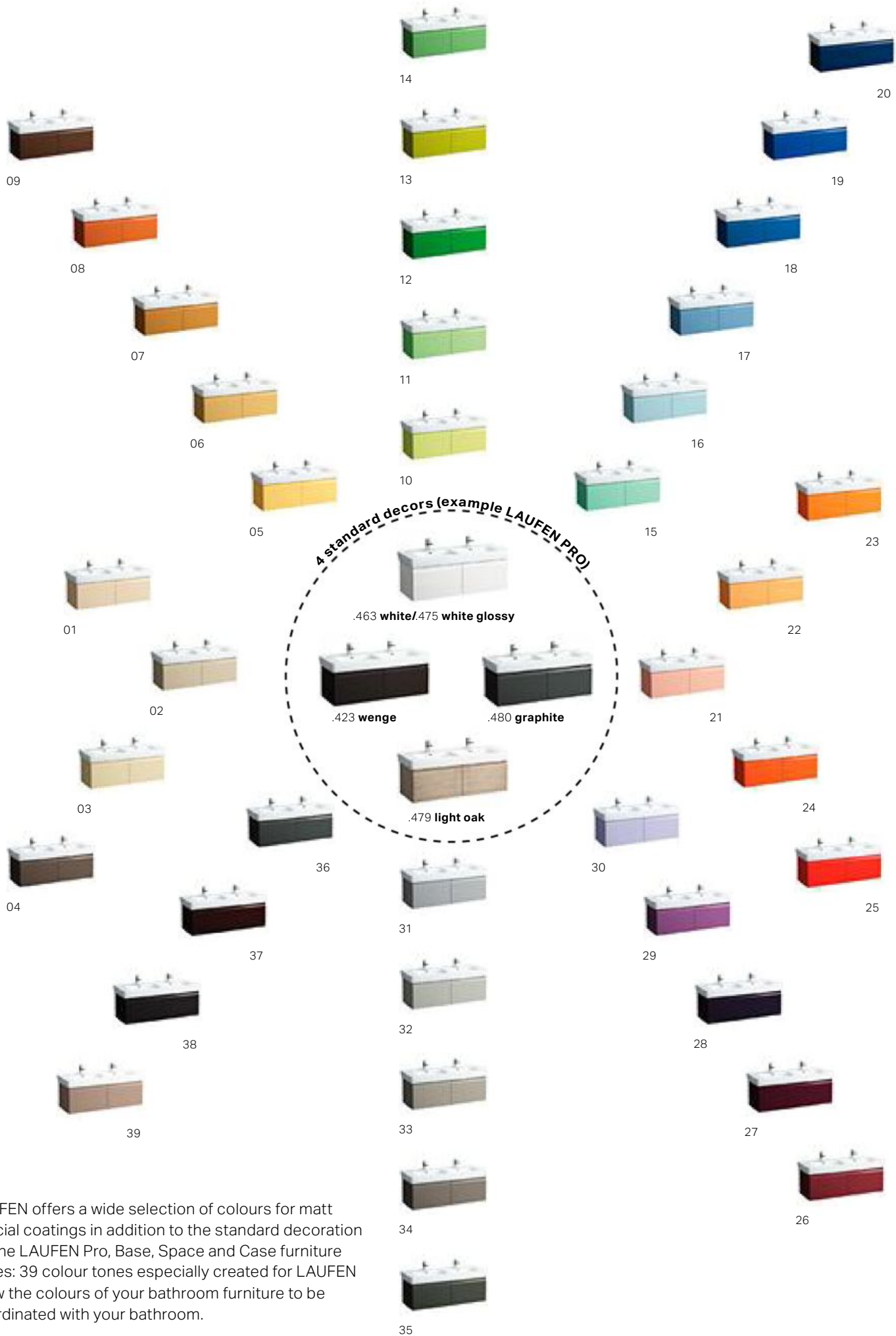



















































NOTES

































LAUFEN offers a wide selection of colours for matt special coatings in addition to the standard decoration for the LAUFEN Pro, Base, Space and Case furniture series: 39 colour tones especially created for LAUFEN allow the colours of your bathroom furniture to be coordinated with your bathroom.

OVERVIEW FURNITURE COLOURS

SONAR					
 .040 Gold	 .041 Copper	 .042 Titanium	 .140 Gold & nero marquina	 .141 Copper & nero marquina	 .142 Titanium & nero marquina
THE NEW CLASSIC					
 .631 White glossy	 .627 Traffic Grey	 .628 Blacked Oak	 .629 Walnut for washbasin frame		
ILBAGNOALESSI ONE					
 .630 Noce canaletto	 .631 White glossy				
PALOMBA COLLECTION					
Vanity units, cabinets					
 .220 White	 .222 Cherry Vermont dark				
Back walls					
 .220 Mirror	 .222 Cherry Vermont dark	 .226 orange	 .227 ruby red	Boxes	
				 .220 White	 .224 pigeon blue
KARTELL BY LAUFEN					
 .640 White matt	 .641 Pebble grey	 .642 Slate grey	INO		
			 .170 White Matt	 .171* Dark walnut	
LAUFEN PRO					
 .423 Wenge structured	 .463 White matt				
		 .475 White glossy			
		 .999 Multicolour (laquered)			
LAUFEN PRO S					
 .423 Wenge structured	 .463 White matt				
		 .475 White glossy			
 .479 Bright oak structured	 .480 Graphite	 .999 Multicolour (laquered)			
LAUFEN PRO B					
 .423 Wenge structured	 .463 White matt				
		 .475 White glossy			
		 .999 Multicolour (laquered)			
BOUTIQUE					
 .250 Light oak	 .251 Dark oak				
CASE					
 .463 White matt	 .475* White glossy	 .519 Chalked oak	 .548 Anthracite oak	 .999* Multicolour (laquered)	
SPACE					
 .100 White matt, with handle aluminium	 .101 Light walnut, with handle aluminium	 .103 Dark elm, with handle dark brown aluminium	 .999* Multicolour (laquered)		
BASE					
 .260 White matt	 .261 White glossy	 .262 Light elm	 .263 Dark elm	 .999 Multicolour (laquered)	
 .M01 Oyster white	 .M36 Traffic grey				

OVERVIEW COLOURS WELLNESS / ACCESSORIES

BATHTUBS SONAR / THE NEW CLASSIC / ILBAGNOALESSI ONE / PALOMBA COLLECTION / KARTELL BY LAUFEN / INO / VAL / LAUFEN PRO / LAUFEN SOLUTIONS

 .000 White					
SHOWER TRAYS LAUFEN PRO					
 .000 White matt, structured	 .077 Light grey matt, structured	 .078 Anthracite matt, structured	LAUFEN PRO / PALLADIUM		
			 .000 White	 .600 White antislip	
TOWEL HOLDER CASE					
 .104 Anodised aluminium, glossy	 .105 Anodised aluminium	 .106 Anodised aluminium, dark brown			
DISCS KARTELL BY LAUFEN					
 .081 Amber	 .082 Tangerine orange	 .084 Transparent crystal	 .085 Smoky grey	 .090 Opaque white	
 .091 Opaque black	 .092 Emerald green	 .093 Powder pink			
ACCESSORIES KARTELL BY LAUFEN					
 .081 Amber	 .082 Tangerine orange	 .083 Blue	 .084 Transparent crystal	 .085 Smoky grey	 .086 Silver
 .087 Gold	 .089 Copper	 .090 Opaque white	 .091 Opaque black	 .092 Emerald green	 .093 Powder pink

Not all colours available for all models. For more details see technical catalogue or laufen.com

OVERVIEW CERAMIC COLOURS

ILBAGNOALESSI ONE



PALOMBA COLLECTION / LAUFEN PRO S



KARTELL BY LAUFEN



SONAR / VAL / INO / THE NEW CLASSIC



LIVING SQUARE / LIVING CITY / PALACE



LIVING SAPHIRKERAMIK / UNIVERSAL



LAUFEN PRO/ LAUFEN PRO A/ LAUFEN PRO B



CLEANET RIVA / CLEANET NAVIA

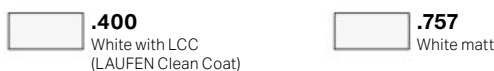

FLORAKIDS



Not all colours available for all models. For more details see technical catalogue or laufen.com

PHOTOGRAPHY

THE NEW CLASSIC

Oliver Helbig

SONAR

Six & Five

ILBAGNOALESSI ONE

Fabrizio Bergamo, Giuseppe Pino, Maurizio Marcato

PALOMBA COLLECTION

Adriano Brusaferrri, Max Majola, Carlo Cirauda, Maurizio Marcato, Luca Fregoso, Max Zambelli

KARTELL BY LAUFEN

Max Zambelli Adriano Brusaferrri

LIVING

Max Zambelli, Christoph Kern, Maurizio Marcato, Studio Casa

VAL

Max Zambelli, Adriano Brusaferrri

INO

Max Zambelli, Adriano Brusaferrri

PALACE

Studio Casa

LAUFEN PRO

Max Zambelli, Christoph Kern, Maurizio Marcato, Studio Casa

CLEANET RIVA

François Halard, Max Zambelli

CLEANET NAVIA

Sara Magni

FLORAKIDS

Maurizio Marcato

CASE

Max Zambelli, Andrea Pitari

SPACE

Max Zambelli, Adriano Brusaferrri

BOUTIQUE

Max Zambelli, Adriano Brusaferrri

BASE

Max Zambelli

ANTERO

Adriano Brusaferrri

LEELO

Oliver Helbig

It is possible that not all products, sizes or colours are available in every country.

The price list of your LAUFEN/ROCA subsidiary is the most accurate reference point for product availability. Delivery periods may differ.

Colours shown may not be absolutely identical to the actual colours.

Bathroom environments shown here are simply decorative settings and do not take all technical requirements into consideration.

Decorations shown are not included in our range of products.

We reserve the right to change specifications without prior notice. We can provide you with the actual data on our website www.laufen.com. Design is copyright protected.

Printed on certified paper from sustainably managed forests.

OVERVIEW CERAMIC OPTIONS

Options for washbasins

- .104** one tap hole, centre
- .105** one tap hole, left
- .106** one tap hole, right
- .107** two tap holes
- .108** three tap holes
- .109** without tap hole
- .111** one tap hole, without overflow hole
- .112** without tap hole, without overflow hole
- .113** one tap hole, left, without overflow hole
- .114** one tap hole, right, without overflow hole
- .135** one tap hole, cuttable on one side
- .136** three tap holes US/CAN, 8 inches apart
- .142** without tap hole, without overflow hole, without open drain

- .147** one tap hole, cuttable on two sides
- .155** outer surface glazed
- .156** one tap hole, without overflow hole, without open drain
- .158** three tap holes, without overflow
- .503** one tap hole, basin middle, with overflow
- .811** one tap hole, with overflow, cuttable on one side
- .812** one tap hole right, cuttable on one side
- .813** without tap hole, cuttable on one side
- .814** one tap hole, one hole on the right side
- .815** one tap hole, one hole on the right side, without overflow

Options for bidets

- .302** with one tap hole at centre, without lateral holes for water inlet
- .304** with one tap hole at centre, with lateral holes for water inlet
- .308** 3 tap holes, without lateral holes for water inlet

Options for urinals

- .400** with fly
- .401** with waste water pipe DN 50
- .411** with fly, with waste water pipe DN 50

Tap hole symbols

- = without tap hole
- = one tap hole
- = two tap holes
- = three tap holes

Headquarters:

LAUFEN Bathrooms AG
Wahlenstrasse 46
CH-4242 Laufen
Tel. +41 61 765 71 11
feedback@laufen.ch
www.laufen.com

Export:

LAUFEN Bathrooms AG
Wahlenstrasse 46
CH-4242 Laufen
Tel. +41 61 765 74 74
export@laufen.ch
www.laufen.com/export

Asia:

Roca Sanitaryware Ltd.
Room 2303, 23/F
148 Electric Road
North Point, Hong Kong
Tel. +852 250 624 38
Fax +852 250 624 92
laufenasia@hongkong.laufen.ch
www.laufen.com/export

Oceania:

Australia, New Zealand & other
Bathroom Products Australia P/L
2/97 Banksia St.
Botany NSW 2019
Australia
Tel. +61 (0)2 9290 2331
aus.admin@roca.net
www.laufen.com.au

Austria:

LAUFEN Austria AG
Mariazeller Strasse 100
A-3150 Wilhelmsburg
Tel. +43 2746 6060
Fax +43 2746 6060 380
office.wi@at.laufen.com
www.laufen.co.at

**Bosnia and Herzegovina,
Croatia, Kosovo, Macedonia,
Montenegro, Serbia, Slovenia:**

Roca Croatia d.d.
Industrijska 1
HR-10290 Zapresic
Tel. +385 (0) 1 3350 825
Fax +385 (0) 1 3310 594
komercijala@inker.hr
www.laufen.hr

Benelux:

LAUFEN Benelux B.V.
Meidoornkade 2A
NL-3992 AE Houten
Tel. +31 (0)33 450 20 90
info.benelux@laufen.ch
www.laufen.nl
www.laufen.be

Brazil:

Roca Sanitários Brasil Ltda.
Av. 14 de Dezembro
2.800 – V. Mafalda
CEP: 13206 – 105
Jundiaí – SP – Brasil
PABX: +55 11 3378 4600
Assistência Técnica: 0800 70 11 510
info.br@laufen.com
www.laufen.com.br

Bulgaria:

Roca Bulgaria AD
5, Pirotska Str.
1301 Sofia, Bulgaria
Tel. +359 2 930 59 10
Fax +359 2 930 59 18
office.sofia@bg.roca.net
www.bg.roca.com

China:

Roca Sanitary Trading
(Shanghai) co. Ltd
Room 503-505, City Gateway
No. 396 North Caoxi Road
Shanghai 200030, China
Tel. +86 21 3368 8822
Fax +86 21 3368 8299
laufen_cn@roca.net.cn
www.cn.laufen.com

Czech Republic:

LAUFEN CZ s.r.o.
Laufen Prague Gallery
I.P.Pavlova 5
120 00 Praha 2
Tel. +420 296 337 701
prague.gallery@cz.laufen.com
www.laufen.cz

Estonia:

LAUFEN Nordic ApS
Anna Varres
Tel. +372 5665 0589
office.tallinn@ee.laufen.com
www.laufen.ee

France:

Roca S.A.R.L.
Marque LAUFEN
Immeuble le Rond Point
5 Boulevard de l'Oise
F-95015 Cergy Pontoise Cédex
Tel. +33 1 34 40 39 00
Fax +33 1 30 37 02 65
commercial@roca.fr
www.laufen.fr

Germany:

LAUFEN Deutschland
Roca GmbH
Feincheswiese 17
D-56424 Staudt
Tel. +49 2602 93 61 0
Fax +49 2602 93 61 55
info.staudt@de.laufen.com
www.de.laufen.com

Hungary:

LAUFEN CZ s.r.o.
Hungarian Trade Agency
Hűvösvölgyi út 124
H-1021 Budapest
Tel. +36 1 274 05 35
office.budapest@hu.laufen.com
www.laufen.hu

India:

Roca Bathroom Products Pvt. Ltd.
3rd Floor, Tower B,
DLF Building No. 10, Phase – II
DLF Cyber City,
Gurgaon – 122002, Haryana
India
Tel. +91 124 4278347-49
Fax +91 124 4278350
Info.laufen@in.roca.com
www.laufen.in

Italy:

LAUFEN CZ s.r.o.
V Tűních 3/1637
CZ-120 00 Praha 2
Tel. +39 02 90016001
Fax +39 02 90016011
info@it.laufen.com
www.laufen.it

Latvia:

LAUFEN Nordic ApS
Dita Osmolovska
Tel. +371 2631 9340
office.riga@lv.laufen.com
www.laufen.lv

Lithuania:

LAUFEN Nordic ApS
Užupio g. 30
Vilnius, 01203
Lietuva
Tel. +370 5 215 30 76
office.vilnius@lt.laufen.com
www.laufen.lt

Morocco:

Roca Maroc, S.A.
route de Marrakech, km 2,5
BP 571, 26000 Settat
Tel. +212 5 23 40 59 41
Fax +212 5 23 40 59 42
www.roca.com

Nordic Countries:**Denmark, Finland, Greenland, Iceland**

LAUFEN Nordic Aps
Tømrervej 2
4600 Køge
Denmark
Tel. +45 56 287 287
info@dk.laufen.com
www.laufen.dk
www.laufen.fi

North America:

LAUFEN Bathrooms North America
Showroom
7610 NE 4th Court, Suite 104
Miami, FL 33138
USA
Toll free phone +1 (866) 696-2493
+1 (305) 357-6130
Toll free fax +1 (866) 628-1760
usa@laufen.com
canada@laufen.com
www.laufen.com/usa
www.laufen.com/ca
www.laufen.com.mx

Norway:

Laufen Norge AS
Syretårnet 41
NO-3048 Drammen
Tel.: +47 32 27 60 70
firmapost@no.laufen.com
www.laufen.no

Poland:

Roca Polska Sp. z o.o.
ul. Wycóżkowskiego 20
44-109 Gliwice
Tel. +48 32 339 41 00
biuro@roca.pl
www.laufen.pl

Portugal:

Roca, S.A., Portugal
Apartado 575, Ponte da Madalena
2416-905 - Leiria, Portugal
Tel. +351 244 720 000
marketing.le@pt.roca.net
www.laufen.pt

Romania:

Roca Obiecte Sanitare S.R.L.
Blvd. Preciziei nr. 1, Sector 6
062202 - Bucharest – Romania
Tel. +4031 822 2310
Fax +4021 318 1418
www.ro.roca.com

Russia:

Roca Rus
Promyshlennaya Str. 7, Tosno
Leningrad region, 187000, Russia
Tel. +7 812 347 94 49
marketing@ru.roca.net
www.laufen.ru

Roca Rus

2nd Khutorskaya, 38A, building 14
Moscow, 127287, Russia
Tel. +7 495 989 65 91
marketing@ru.roca.net
www.laufen.ru

Slovakia:

LAUFEN SK s.r.o.
Štefanovičova 12
811 04 Bratislava
Tel. +421 2 526 210 24
office.bratislava@sk.laufen.com
www.laufen.sk

Spain:

Laufen Bathrooms S.A.
C / Covarrubias 23
28010 Madrid
Spain
Phone: +34 900 103 258
info@es.laufen.com
www.laufen.es

Sweden:

Laufen Sverige AB
Kämpegatan 15
SE-41104 Göteborg
Tel. +46 (0) 823 44 44
info@se.laufen.com
www.laufen.se

Switzerland:

Keramik Laufen AG
Wahlenstrasse 46
CH-4242 Laufen
Tel. +41 61 765 71 11
forum@laufen.ch
www.laufen.ch

Ukraine:

LAUFEN CZ s.r.o. Ukraine
Kiev 04128
19, Ak. Tupoleva str., office «Laufen»
Tel. +380 44 499 0620
Fax +380 44 499 0621
office.kiev@ua.laufen.com
www.ua.laufen.com

United Kingdom and Ireland:

Laufen Ltd
Interlink Way West
Bardon
Coalville
Leicestershire
LE67 1LD
Tel. +44 (0)1530 510007
laufen@uk.roca.net
www.uk.laufen.com



www.laufen.com



download brochures



www.laufen.com/bimobjects
www.facebook.com/laufenbathrooms
www.twitter.com/laufenbathrooms
www.youtube.com/laufenbathrooms1
www.instagram.com/laufenbathrooms
www.pinterest.com/laufenbathrooms

LAUFEN Bathrooms AG
Wahlenstrasse 46
4242 Laufen
Switzerland
Tel. +41 61 765 71 11
www.laufen.com